

2021 | 2022

# WEINSBERG

*Dein Urlaub!*

## ON THE ROAD



### SEMI-INTEGRATED

CaraCompact / CaraLoft / CaraSuite



### ALCOVE

CaraHome



### FULLY INTEGRATED

CaraCore

[www.weinsberg.com](http://www.weinsberg.com)



**YOUR HOLIDAY!  
DISCOVER  
NEW SIDES.**



With WEINSBERG every moment of your holiday becomes an experience. From driving off to returning home, it is your companion for all adventures – perfectly tailored to your individual requirements and needs.

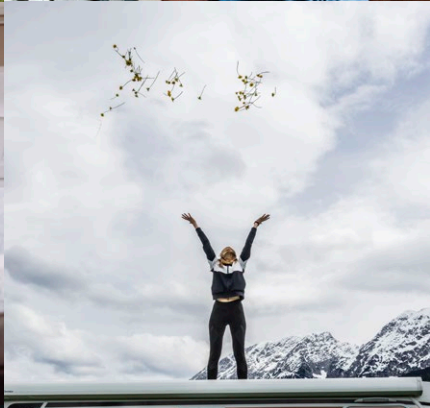
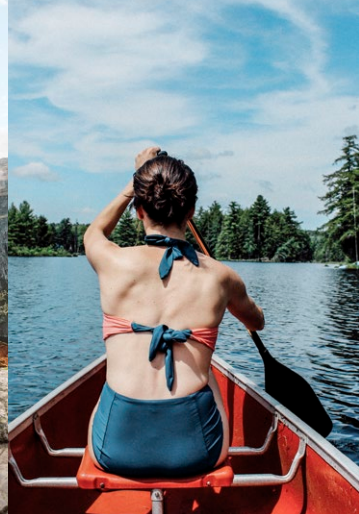

**DISCOVERING  
TOGETHER  
IS THE  
BEST.**



**SPACE  
ENOUGH FOR  
EVERYONE AND  
EVERYTHING.**

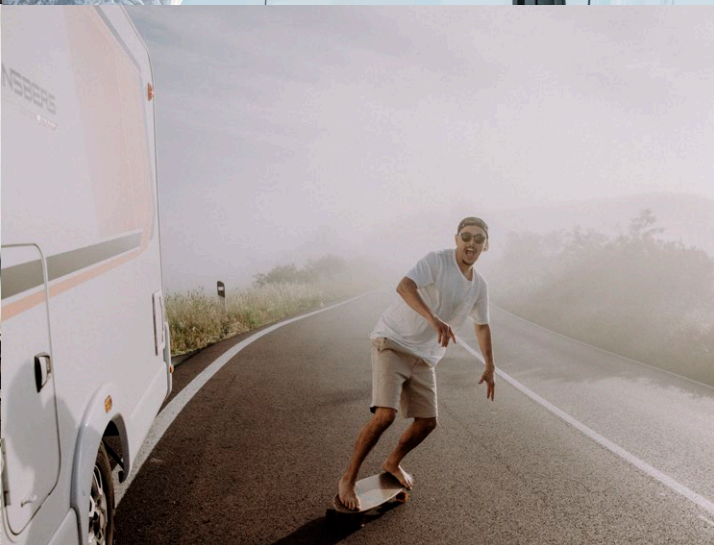



**FEELINGS OF  
HAPPINESS  
ALL-  
INCLUSIVE.**

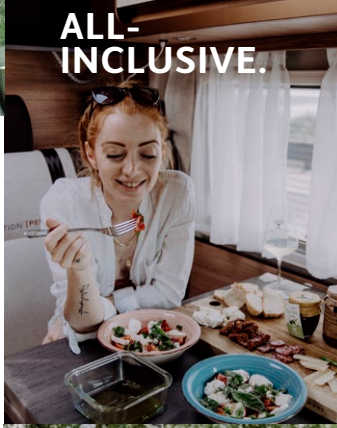

# #team **WEINSBERG**

*Welcome to the world of WEINSBERG. Whether romantic togetherness, a cosy family holiday or a sporty outing with friends, the focus is always on the shared experience with special people. Extraordinary people and moments also make up #teamWEINSBERG. #teamWEINSBERG offers you the opportunity to be inspired by other travel stories, to get practical tips for your holiday and to share your love of camping with others.*



**WEINSBERG  
THE SUM OF ALL  
HOLIDAY MOMENTS.**

**EVERYDAY  
LIFE.  
WHAT IS  
THAT?**



# 16

 **SEMI-INTEGRATED**  
**CaraCompact**

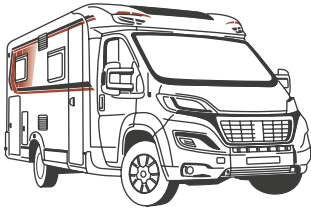

### The agile and slim semi-integrated van class

Best driving dynamics on all roads is easy for the CaraCompact. In the interior, it offers exceptional space, clever details and flexible solutions.

**A dashing companion.**

[www.weinsberg.com/caracompact](http://www.weinsberg.com/caracompact)

# 36

 **SEMI-INTEGRATED**  
**CaraLoft**



### The semi-integrated with the largest payload

The sovereign semi-integrated offers plenty of space for great holiday experiences. You could say that it sets new standards in terms of payload and feeling of space.

**A generous all-rounder.**

[www.weinsberg.com/caraloft](http://www.weinsberg.com/caraloft)

# 52

 **SEMI-INTEGRATED**  
**CaraSuite**

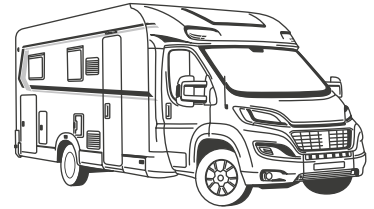

### The semi-integrated with lifting bed and largest headroom

With its ingenious headroom and the practical lifting bed, the CaraSuite offers plenty of space for great holiday experiences. Its many sleeping possibilities and cosy ambience make it the ideal family or mult-generation vehicle.

**A comfortable size.**

[www.weinsberg.com/carasuited](http://www.weinsberg.com/carasuited)

# 68

 **ALCOVE**  
**CaraHome** **NEW**



### The family-friendly alcove with outstanding space

With its alcove and the well thought-out room division, the CaraHome offers enough space for beautiful holiday experiences. Depending on the layout, it can accommodate up to 6 people.

**Mobile family home.**

[www.weinsberg.com/carahome](http://www.weinsberg.com/carahome)

# 84

 **FULLY INTEGRATED**  
**CaraCore**



### The fully integrated with sovereign equipment and presence

It skilfully combines utility with design. Dynamics and high quality are in his blood. 100% strong appearance, 100% WEINSBERG DNA.

**Style-conscious trendsetter.**

[www.weinsberg.com/caracore](http://www.weinsberg.com/caracore)

All specifications partly include optional extras which are available at extra cost.

Please note that the number of beds indicated may include beds for both adults and children. The beds do not have the same dimensions. We therefore recommend that you consult your WEINSBERG dealer about the dimensions of the beds provided in the vehicle so that you can decide whether they are suitable for the occupancy (adults/children) you intend to have. Non-binding representation: The illustrations of the layout examples are non-binding schematic representations. The actual vehicle and equipment features may differ. Certain vehicle and equipment characteristics are not guaranteed by the illustrations and cannot therefore be expected to be based on them. Therefore, please be sure to obtain information from your dealer about the specific characteristics of the vehicle and equipment you have selected before making a purchase. In summer 2021, the FIAT base vehicle will be replaced from the DUCATO 7 to the DUCATO 8. Unfortunately, it is not possible for organisational reasons to print the photos of the update at a later date. Therefore, please note that some illustrations of the DUCATO do not correspond to the current (new) series status.

## EDITORIAL

# Your holiday! Discover new sides.

---

*You are at home outside and on the way you are discovering new sides of yourself and your WEINSBERG. No matter if you are travelling with one of our semi-integrated, alcove or fully integrated models: We share your passion and accompany you with well thought-out details. And you'll feel that on every day of your holiday.*

*Your WEINSBERG Crew*

### CaraView

Get to know your personal dream vehicle even better.



#### Layout finder

Guides you with specific questions to the right vehicle.

[layoutfinder.weinsberg.com](https://layoutfinder.weinsberg.com)



#### Configurator

With the vehicle configurator you can put together your individual WEINSBERG.

[configurator.weinsberg.com](https://configurator.weinsberg.com)



#### Insider knowledge

Additional detailed information about the different areas in your desired vehicle.

[weinsberg.com](https://weinsberg.com)

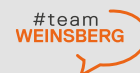

#### #teamWEINSBERG

Community exchange, exciting information and tips about your vehicle from real campers.

# What makes our motorhomes special?

## The sum of many details.

WEINSBERG DNA. Sounds powerful, right? Thanks to the passion and experience of our employees (many of them are enthusiastic campers themselves) we know what is important „out there“. That is why WEINSBERG motorhome competence can be seen in the smallest screw as well as in the large storage space. Motorhome competence is not always visible. But it is noticeable on every journey.

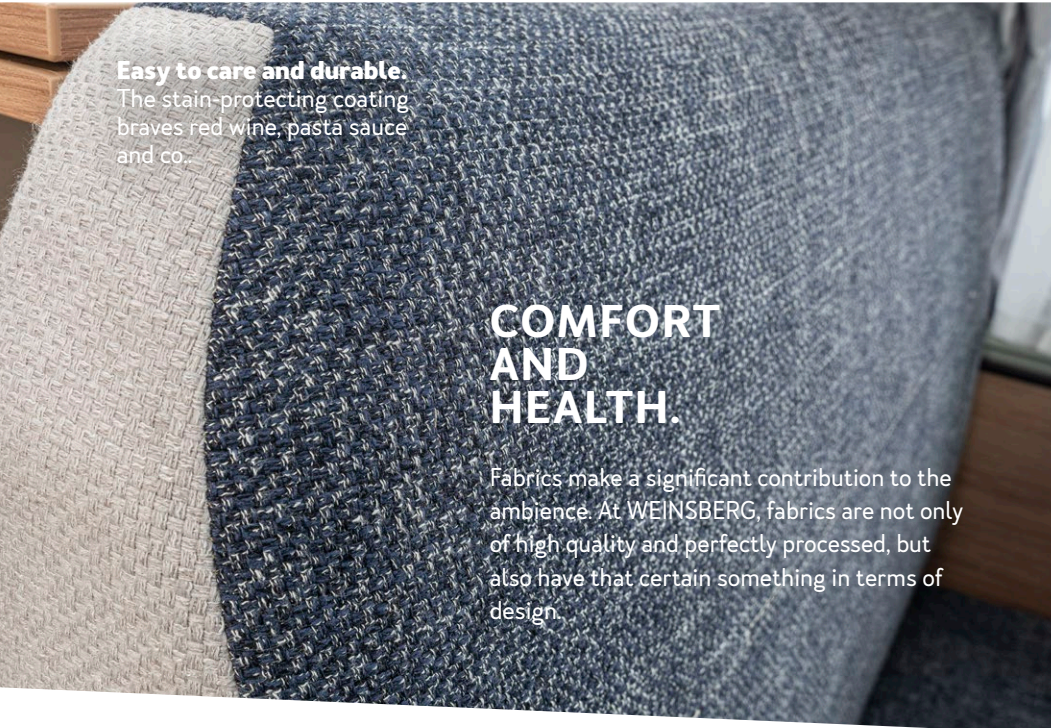

**Easy to care and durable.**  
The stain-protecting coating braves red wine, pasta sauce and co.

### COMFORT AND HEALTH.

Fabrics make a significant contribution to the ambience. At WEINSBERG, fabrics are not only of high quality and perfectly processed, but also have that certain something in terms of design.



**Florian Hopp, Product Manager**  
44 years old, at WEINSBERG since 2015  
**Favourite WEINSBERG detail:**  
The unique interior design.



*Optional ActiveLine fabric covering. Breathable, antibacterial, skin-friendly and ÖKO-TEX certified!*



**HIGHLIGHT**  
All fabrics are **Oeko-Tex 100** certified

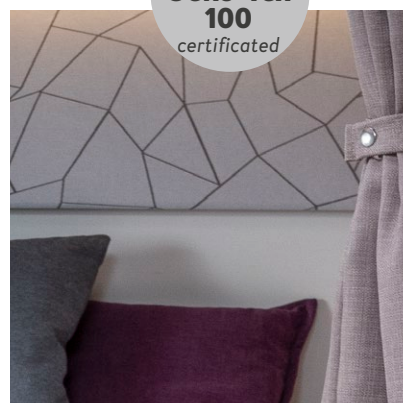
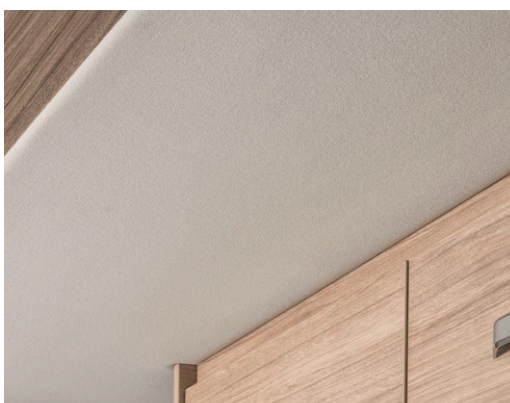

**EvoPore HRC mattresses.** Full sleeping comfort thanks to ergonomic adaption and optimum ventilation.





## SLEEPING, RESTING, DREAMING.

As you make your bed so you must lie on it. At WEINSBERG, exclusively on high-quality slatted frames as standard. These guarantee the best stability and excellent ventilation. Put on the EvoPore mattress and good night!



### 600 MF – Easy.

Fold up the slatted frame and use the storage space underneath.

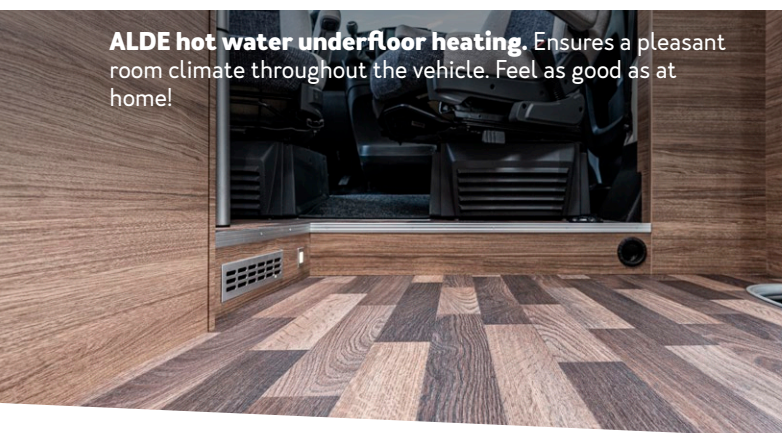

**ALDE hot water underfloor heating.** Ensures a pleasant room climate throughout the vehicle. Feel as good as at home!

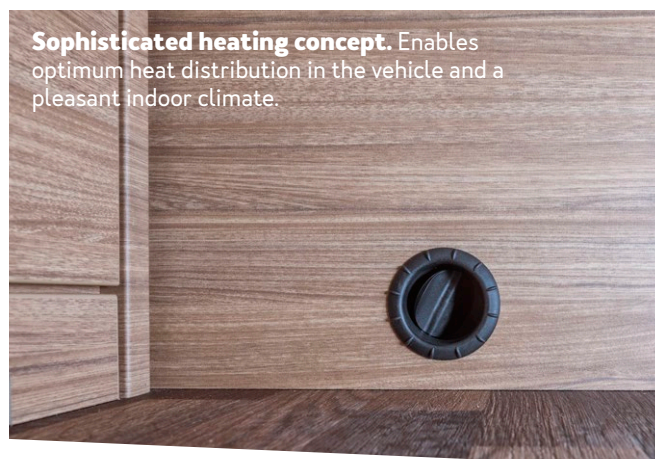

**Sophisticated heating concept.** Enables optimum heat distribution in the vehicle and a pleasant indoor climate.



**Insulating glazing.** For cab side windows and doors with improved sound and heat insulation.

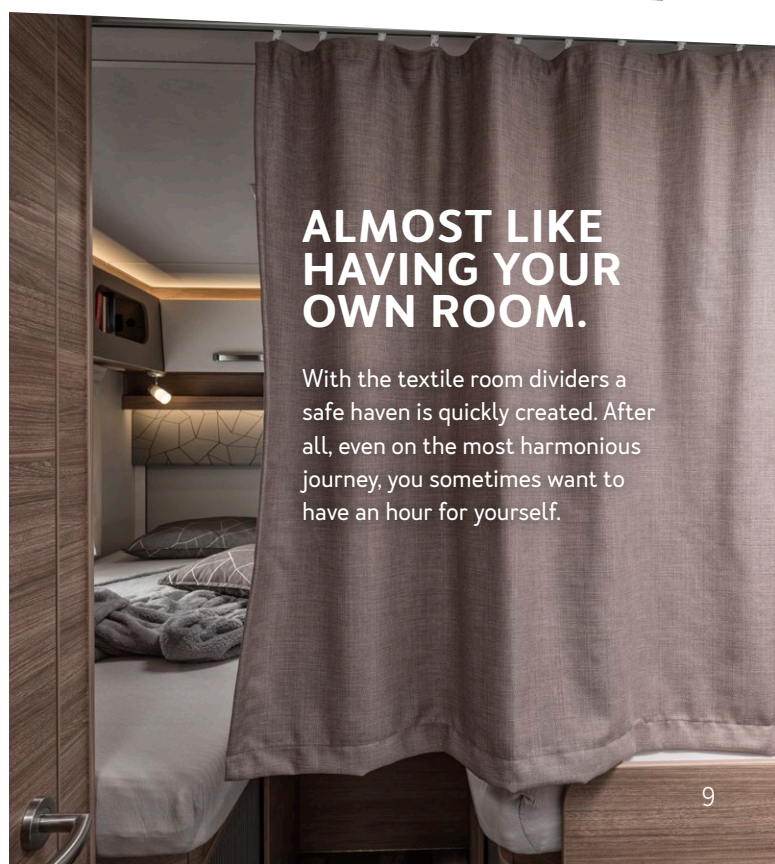

## ALMOST LIKE HAVING YOUR OWN ROOM.

With the textile room dividers a safe haven is quickly created. After all, even on the most harmonious journey, you sometimes want to have an hour for yourself.



**Michal Flöring, Carpenter**  
39 years old, at WEINSBERG since 2016  
**Favourite WEINSBERG detail:**  
Perfect workmanship.

**Full metal handles with a tilt lock.**  
Clear contours and absolutely durable.

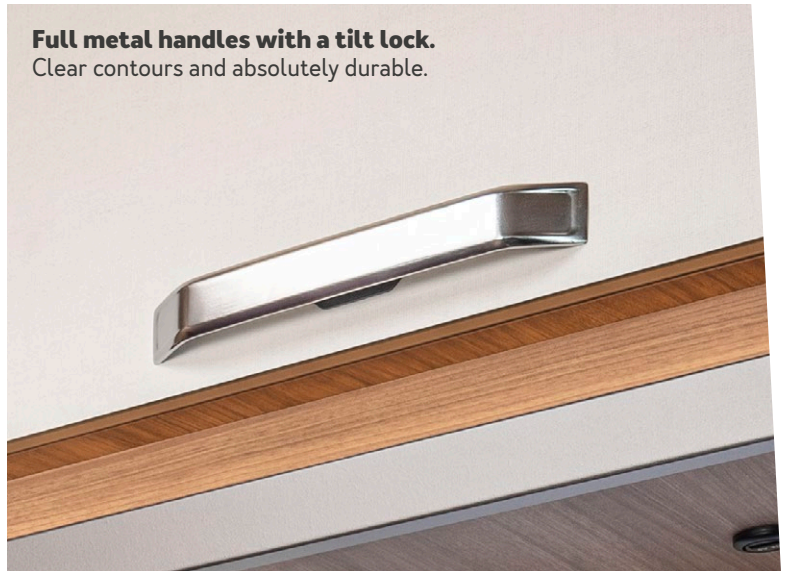

## EVERYTHING FITS TOGETHER PERFECTLY HERE.

Here everything makes a good match. As a dedicated carpenter, I am proud that we at WEINSBERG work of course with an elaborate full-body construction and a precisely fitting dowelling technology.

**Precise dowelling technology.** Provides for a particularly stable furniture construction.

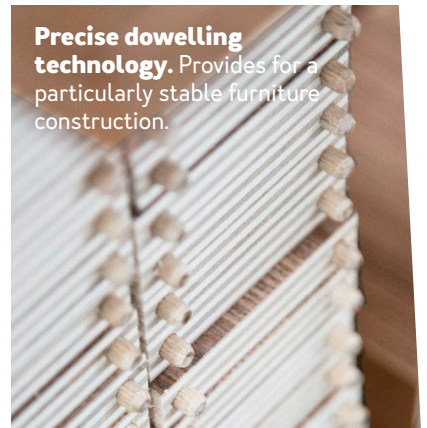

**Precisely fitting processing.** High quality that will delight you for many years.

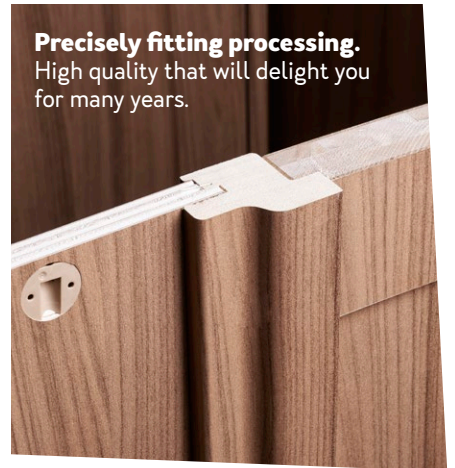

**Soft-close function.** Thanks to high-quality gas pressure absorbers, drawers and furniture doors close gently and silently.

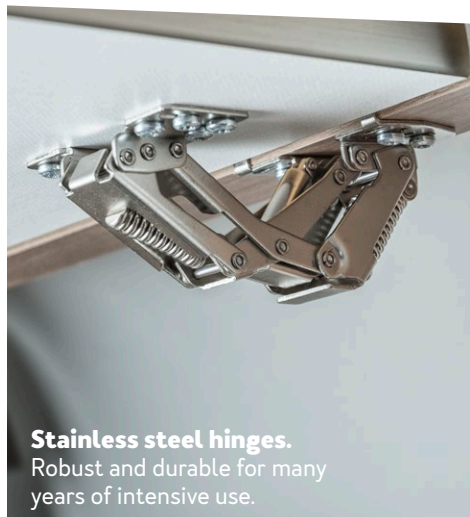

**Stainless steel hinges.** Robust and durable for many years of intensive use.

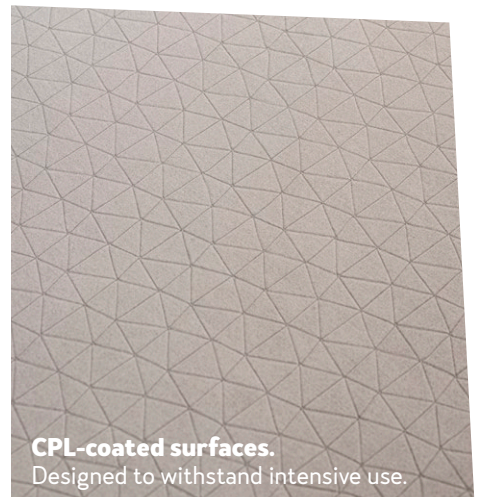

**CPL-coated surfaces.** Designed to withstand intensive use.



## FURNITURE MAKING AND QUALITY.

Full-body construction including back panels. In every WEINSBERG there is a crucial quality criterion: handwork, longevity and long lasting pleasure.



**Furniture with ambient lighting.** High-quality interior design with atmospheric lighting creates a pleasant atmosphere.



**Tomas Sekava, Carpenter**  
54 years old  
**Favourite WEINSBERG detail:**  
The durable full body construction.



**High standard.** We place great value on quality in both processing and design. This can be seen, for example, in the kitchen furniture with cross-grain.

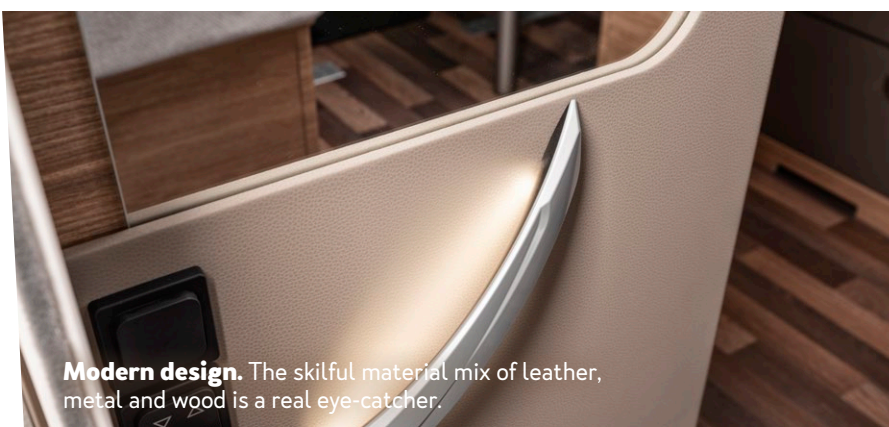

**Modern design.** The skilful material mix of leather, metal and wood is a real eye-catcher.

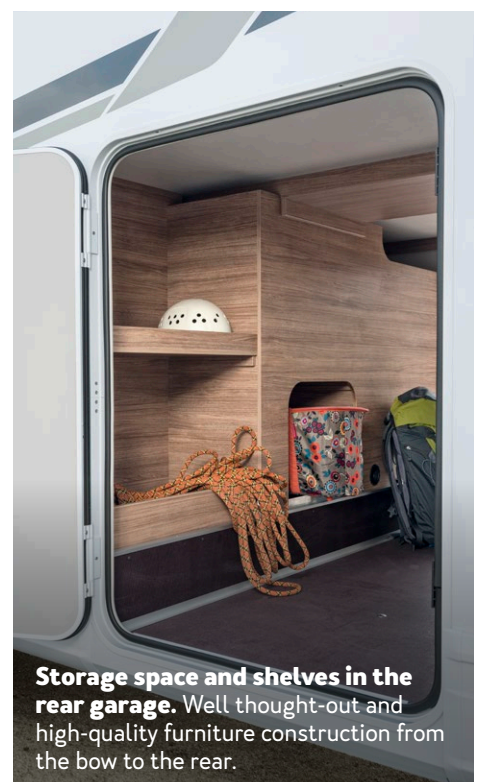

**Storage space and shelves in the rear garage.** Well thought-out and high-quality furniture construction from the bow to the rear.



**Double garage door seal.** Optimum protection against rain and moisture.

**Anna Wintersberger,**  
**production employee**  
26 years old, at WEINSBERG since 2017  
**Favourite WEINSBERG detail:**  
Unique sandwich floor construction.

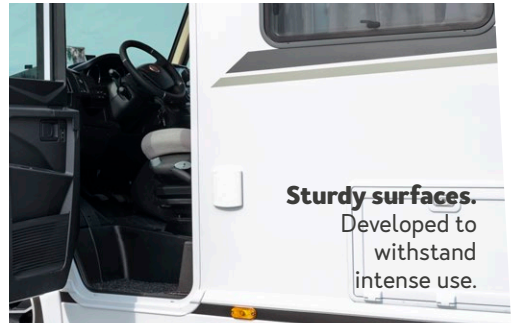

## KNOWLEDGE MEETS SKILLS.

To be able to pay attention to every little detail when assembling the various elements, a lot of knowledge, skill and craftsmanship is required.

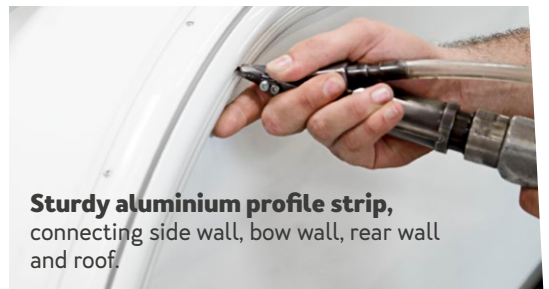

**Durable TVT construction.** Aluminium and insulation materials with polyurethane reinforcements make the vehicle weather-resistant.

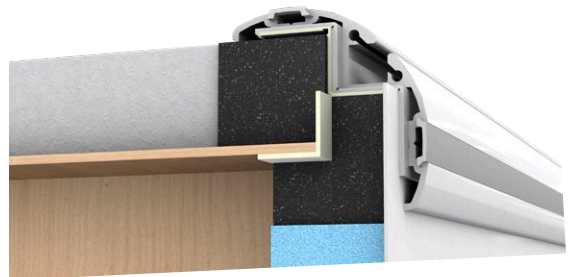



# PERFECT VEHICLE CONSTRUCTION AND LONGEVITY.

We build on security. After all, the future owners should always feel well looked after in our caravans. And that for many years to come.



**Matthias Weishäupl, production worker**

25 years old, at WEINSBERG since 2017

**Favourite WEINSBERG detail:**

The new, perfectly designed roof hoods in LFI technology.

## ROOF HOODS IN LFI-TECHNOLOGY.

- Lighter than GRP
- Machine made
- UV resistant
- Insulation directly integrated
- Easy to repair
- Every part perfect



### **Timeless exterior design.**

High-quality foils and aesthetic design do not look old even after many years.



### **Fender cladding.**

The fastening is not visible from the outside, the seamless transitions guarantee robustness and durability.



**Insulated with EPP.** The high-tech material offers the best protection and reduces driving noise.

# VEHICLE TECHNOLOGY AND SUPPLY.

We strive for the best possible travel experience for our customers. That is why we are extremely careful when selecting our partners and only use what really convinces us. The bluuwater water filter for hygienically clean water is one such example. You can find more information on [» page 114](#)

bluuWater



**USB charging socket.** A practical charging station for smartphone, camera etc.



**Head-up display.** The integrated head-up display provides even more safety. All relevant data in direct view, keeping your eyes on the road.

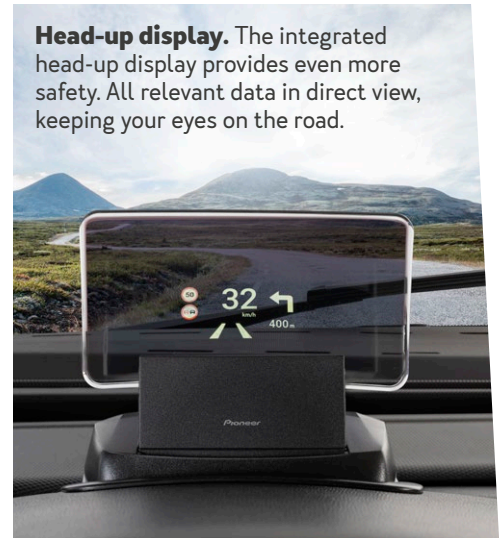

For recreational vehicles of the WEINSBERG brand, we grant you a 10-year tightness guarantee on the bodywork manufactured by us within the framework of our guarantee conditions valid at the time of vehicle delivery, in addition to your statutory guarantee.



**Tanja Eder, Production employee**  
**Favourite WEINSBERG detail:**  
 The easily accessible  
 Easy-Travel-Box.

**Pioneer Navgate Evo.** With 9" multi-touch display and 3-year map update.



**Centrally arranged LED control panel.**

One glance is enough to check the water level and the electronics supply.



**Optional TRUMA iNet-X system.**

Easily control the indoor climate and lighting from anywhere via app or check the battery and water levels.

[» Page 115](#)



Heating systems





**Optional gas locker pull-out.**  
Makes replacing the gas bottles particularly easy.

**Lithium-ion battery.**  
Increased energy capacity with only 11 kg total weight (optional).



**Michael Gründinger, Product developer**  
36 years old, at WEINSBERG since 2016  
**Favourite WEINSBERG detail:**  
User comfort through the centrally located LED control panel.

**Up to 27" SMART TV.** A TV with internet access enables TV streaming. Is this the end of the SAT system?

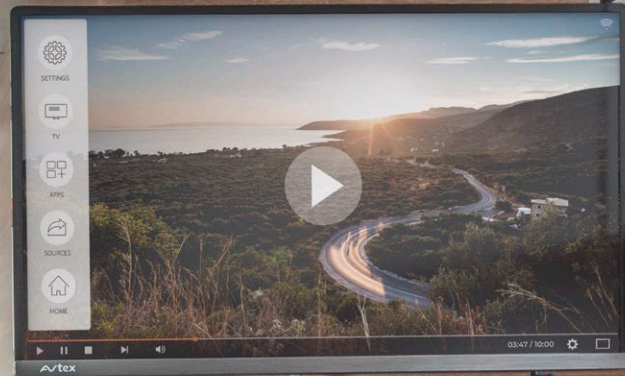

**WE PAY ATTENTION TO SMALL AND BIG DETAILS.**



**Crank support in the rear.**  
Provides additional stability and less vibration when the vehicle is stationary.

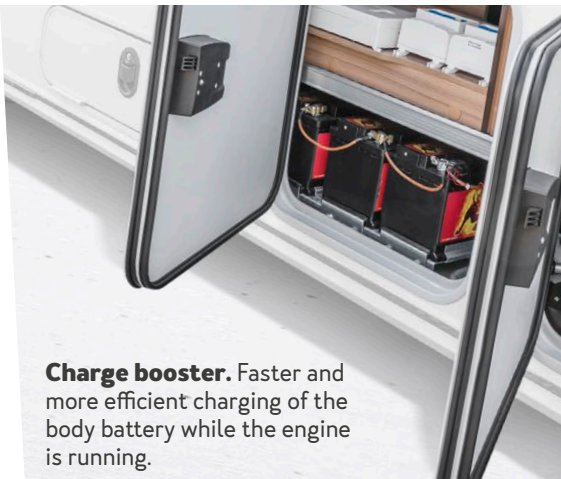

**Charge booster.** Faster and more efficient charging of the body battery while the engine is running.



**Easy-Travel-Box.**  
The complete supply technology centrally in one place. The flap integrated into the side wall gives you quick and easy access to all important elements.



# CaraCompact

**THE AGILE AND SLIM  
SEMI-INTEGRATED OF  
OUR VAN CLASS.**

Best driving dynamics on all roads is easy for the CaraCompact. In the interior, it offers exceptional space, clever details and flexible solutions.

**A SPEEDY COMPANION.**



# WEINSBERG

*Dein Urlaub!*



#team  
WEINSBERG

**Sarah Katharina & Andreas.** *Our definition of a romantic holiday? Setting off together, stopping where we like and simply enjoying the surroundings! One reason why we make a good couple is our love of travel and spontaneity. We are not prepared to forego comfort and cosy living space. In the CaraCompact **EDITION [PEPPER]** we have the perfect companion for our journeys of discovery.*



ADVENTUROUSNESS  
CAN BE  
COMFORTABLE.

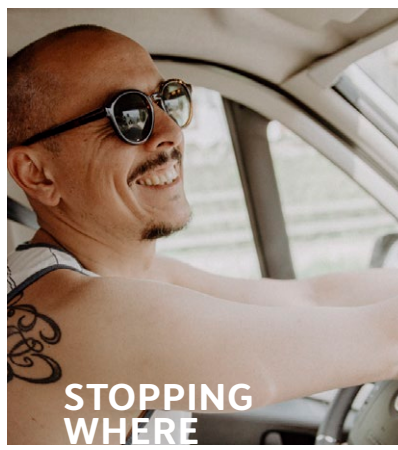

STOPPING  
WHERE  
WE  
WANT.



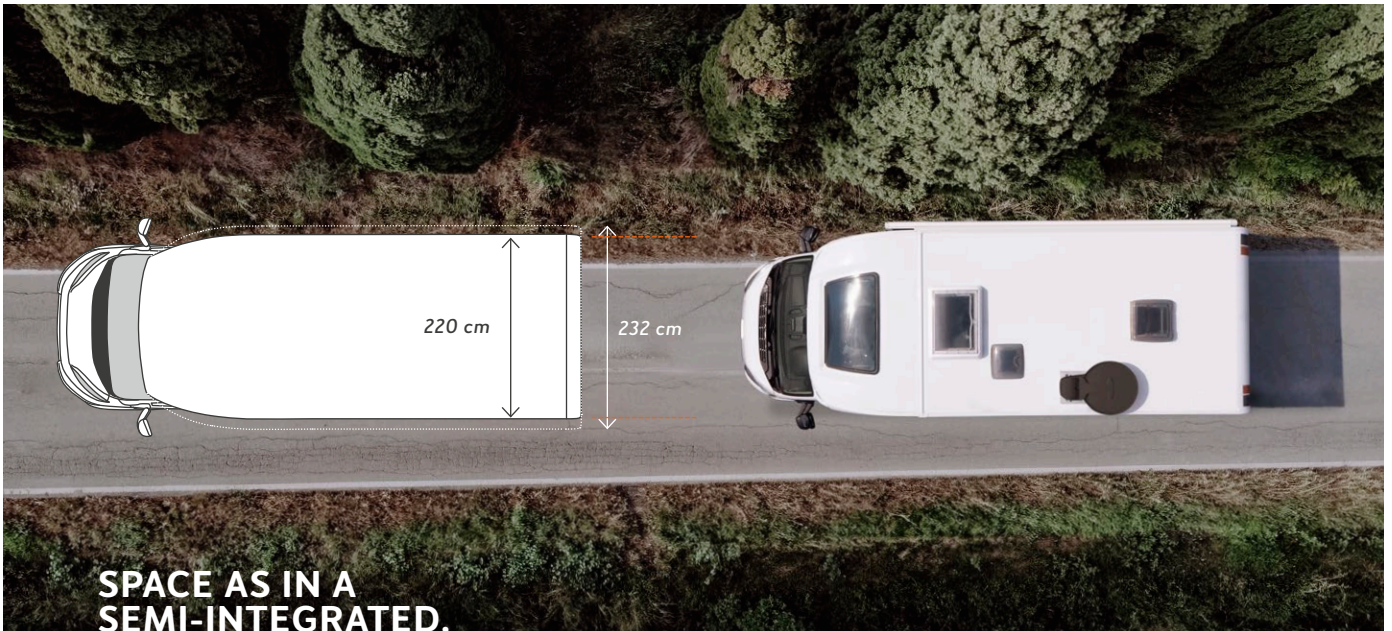

**SPACE AS IN A  
SEMI-INTEGRATED,  
AGILE THANKS TO  
VAN CLASS.**

**600 MEG**



Compact, but oh my. The CaraCompact combines the manoeuvrability of the van class with the spaciousness of a genuine semi-integrated vehicle. Compact on the outside, it offers a lot of space on the inside for everything that enhances the camper life. High suitability for everyday use meets ingenious storage space – what more could one want?

**The 3 highlights:**

- Narrow superstructure for smaller vehicle width of 2.20 m
- Excellent use of space with modern design
- Excellent driving dynamics



2 berths



4 belt-secured seats



2 layouts



under 3500 kg

## AUTOMOTIVE CONTOURS FOR OPTIMAL AERODYNAMICS.



The aerodynamic contours of the roof cover minimise wind noise and maximise the appearance.

**Just drive off.** The CaraCompact is a particularly slim motorhome that is easy to drive in everyday life and on holiday. It combines exceptional driving dynamics with plenty of interior space. With its robust chassis and GRP roof, it is the ideal companion for active explorers.



## AGILE ON THE OUTSIDE, LOTS OF SPACE INSIDE.



The optional Styling Packages further emphasise the sleek lines – here as **600 MF**.

**TYPICALLY  
VAN  
CLASS.**

Sleek aerodynamics;  
low air resistance and  
low CW value.



**SLIM  
STRUCTURE,  
CHIC  
DESIGN.**



Sleek. Taillight carrier with full LED taillights – here at the **600 MEG EDITION [PEPPER]**.



## DRIVING EXPERIENCE LIKE IN A SUV.



## SAFETY AND COMFORT ON THE ROAD.

With the rear and front axle stabiliser, normal travelling is comfortable and pleasant. The CaraCompact even masters an unpaved road without any problems.

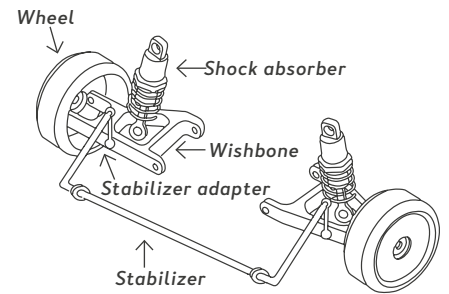

Thanks to the integrated head-up display, the driver's eyes remain where they belong. On the road. Optionally available in the Media Package.

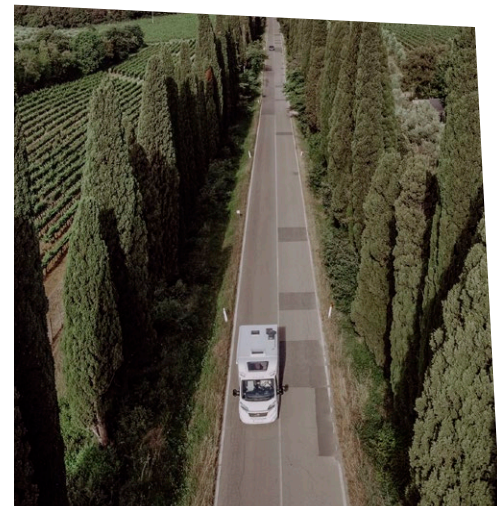

QUITE  
SPACIOUS.

**600 MF EDITION [PEPPER]** – The French bed convinces with its width.

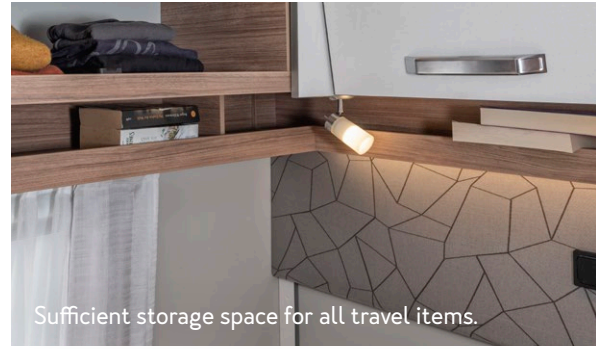

Sufficient storage space for all travel items.



SPACE LIKE  
IN A SEMI-  
INTEGRATED.

**The best of two vehicle worlds.** Narrow roads are easy for the CaraCompact. Its narrow body makes it particularly manoeuvrable and reduces fuel consumption. At the same time, it offers a spacious and well thought-out living-room feeling.

#team  
WEINBERG

**Go on a voyage of discovery.** Our recommendation: With the CaraCompact you can also drive on narrow side roads. It corners well and you never have the feeling that it might be a bit tight.

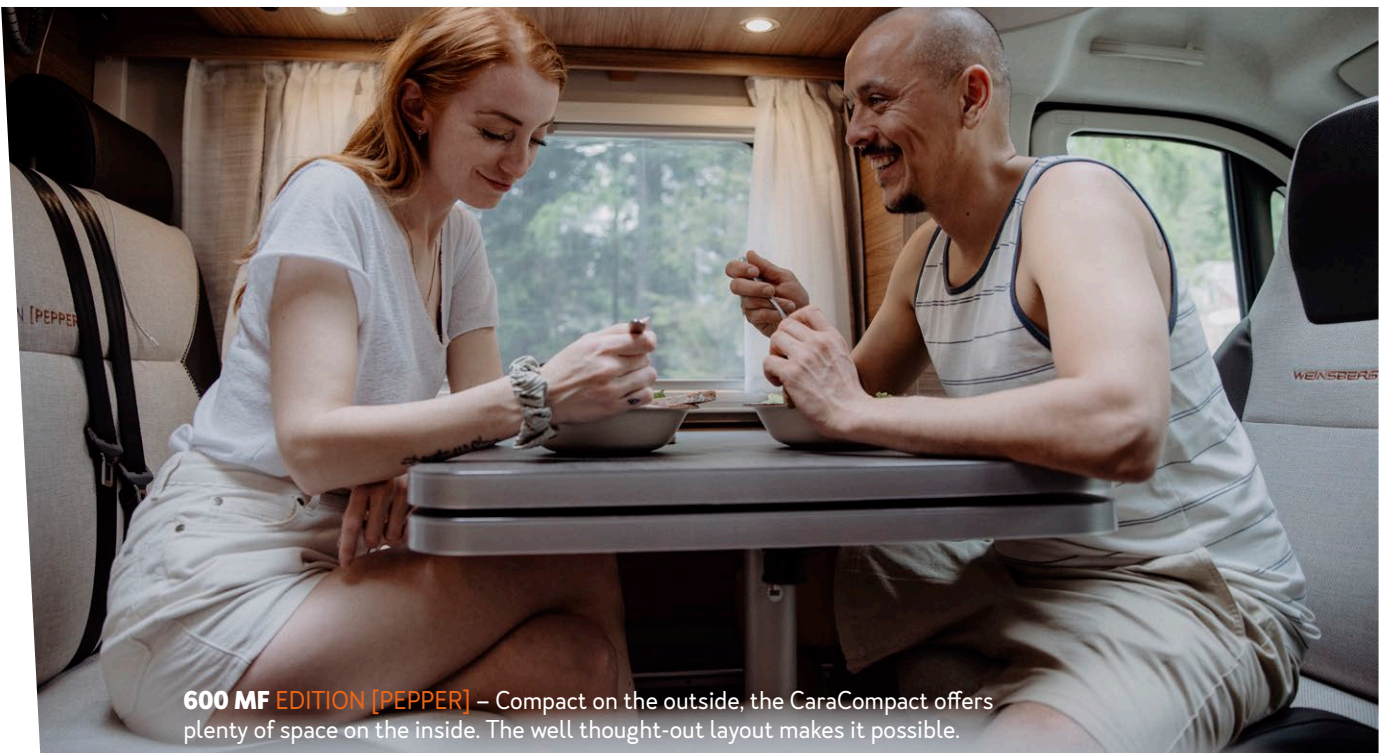

**600 MF EDITION [PEPPER]** – Compact on the outside, the CaraCompact offers plenty of space on the inside. The well thought-out layout makes it possible.

**600 MF EDITION [PEPPER]** – A comfortable sleeping possibility in the French bed. The 130 x 45 cm panorama skylight is available as an option.



140 cm

**FRENCH  
BED.  
FOR  
COSY  
NIGHTS.**



**600 MF EDITION [PEPPER]** – Generous room feeling from every angle.



Pleasant LED lighting.



Chic leather trim on the French bed.



# MORE THAN JUST A SLEEPING PLACE.

**A really good night's sleep.** Cosy, tempting and above all big. The sleeping places in the CaraCompact entice you with a huge lying surface and many comfortable details that make your night even more restful.

#team  
WEINBERG

**Where is it nicer than in bed!** *It would be a shame to use our big bed only for sleeping. So we also read, listen to music and write there. Or we just stretch out and relax.*



## LONGITUDINAL SINGLE BEDS. HERE YOU CAN STRETCH OUT.

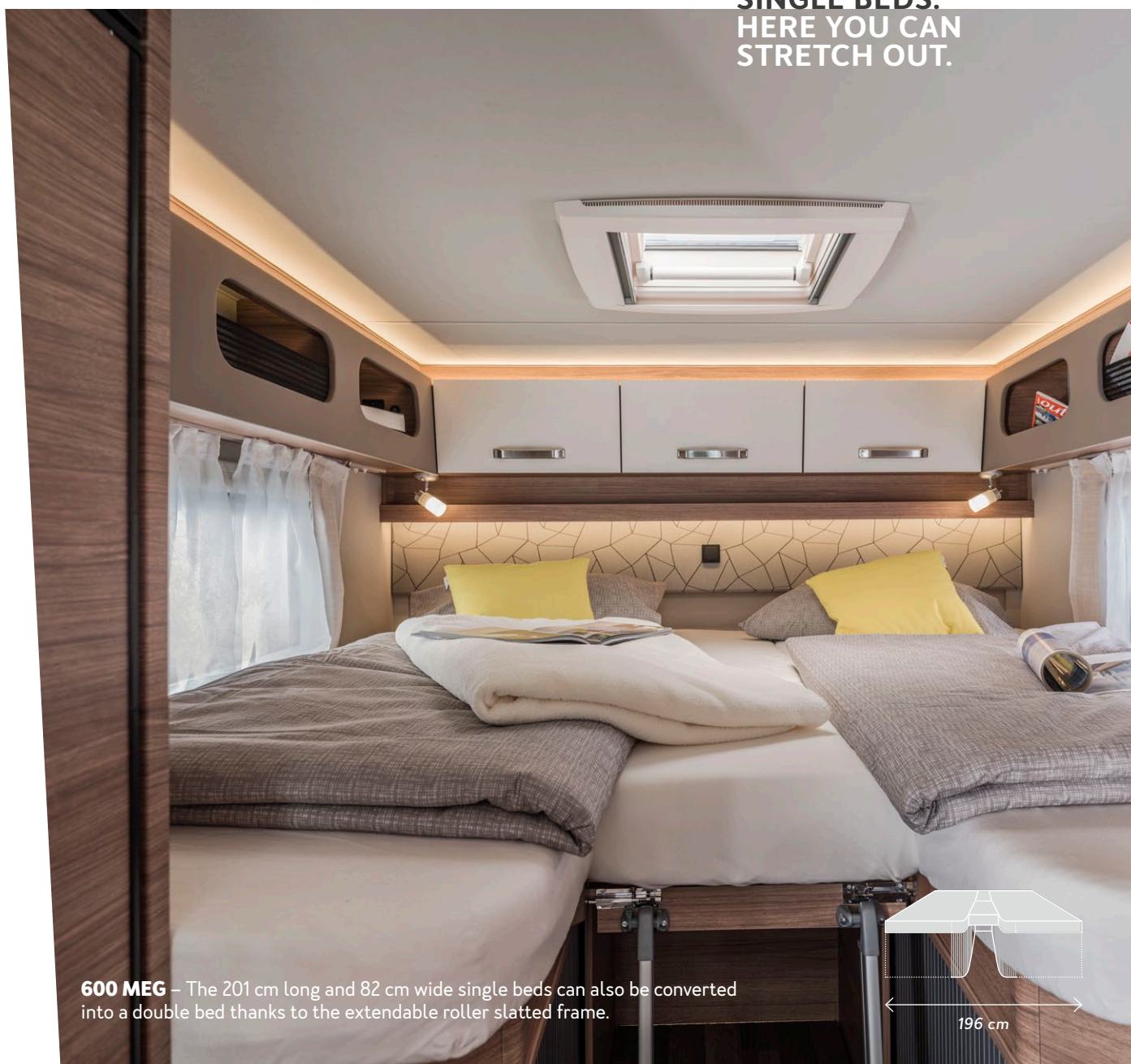

**600 MEG** – The 201 cm long and 82 cm wide single beds can also be converted into a double bed thanks to the extendable roller slatted frame.





**PERFECTLY  
PLANNED FOR  
CONNOISSEURS.**

There is more than enough space between the dinette and the kitchen offering lots of room to move for cooking – here in the **600 MEG EDITION [PEPPER]**.

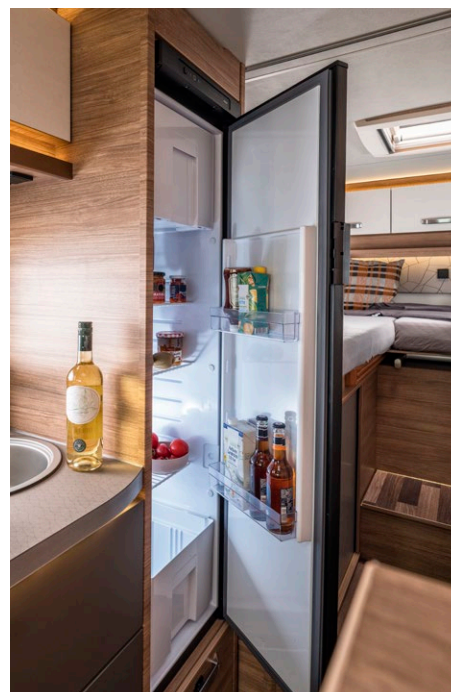
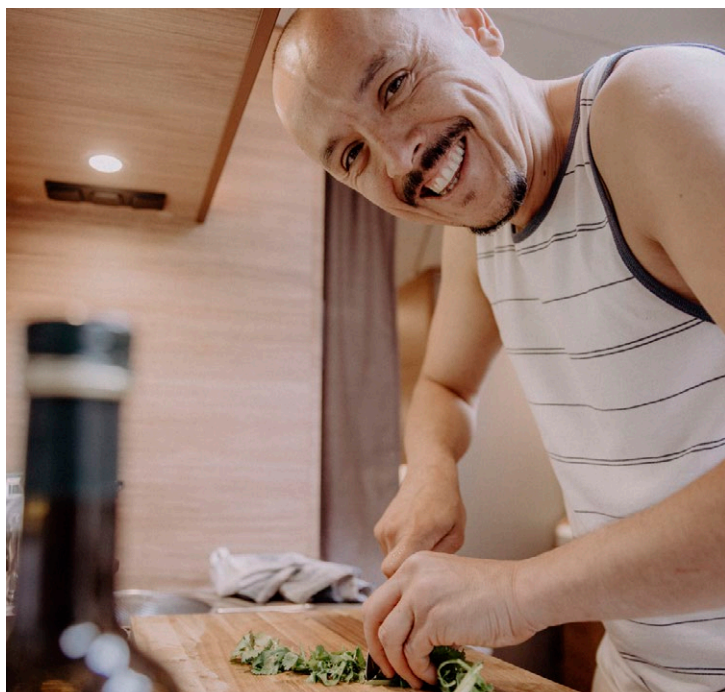

**A lot goes  
in there.**  
SlimTower  
refrigerator  
with 142  
litres.

# WITH SO MUCH SPACE, COOKING IS FUN.

**What a space concept!** The CaraCompact makes particularly efficient use of space with intelligent solutions such as fold-out worktops. The Signature Element in the kitchen exchange cabinet, the cross-grained wood and the harmonious furniture transitions make the CaraCompact unmistakably a genuine WEINSBERG.

#team WEINSBERG

**Perfectly elaborate.** Our motto: Use the potential of your WEINSBERG! For example, by combining the swivelling table extension with the work surface in the kitchen and thus creating a huge area for preparing your food.

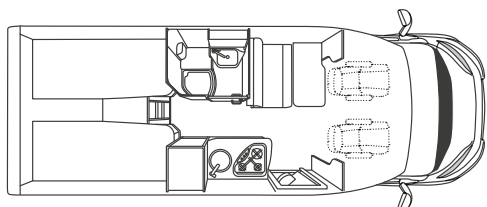

High-quality ball-bearing drawer with soft-close function and cutlery insert.

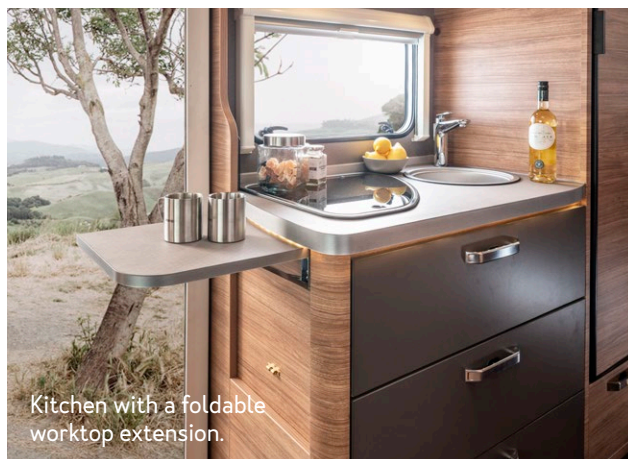

Kitchen with a foldable worktop extension.



COMPACT CAN BE THAT BIG.

Just turn around the captainchair driver's and passenger's seats and take part in the table events – here at the **600 MEG EDITION [PEPPER]**.

# TRUE GREATNESS IS REVEALED IN SMALL DETAILS.



**Every centimetre counts.** With the bathroom in the CaraCompact, you can count on the usual comfort when you're on the road. Clever solutions and details, such as a sliding washbasin or space-saving shower walls, allow you to refresh yourself.

#team WEINBERG

**Perfectly elaborate.** We always like to be prepared for all eventualities, which is why we love the many storage compartments in the bathroom. Everything has its place here: insect bite gel, nail polish remover, first-aid kit, various sun creams...

## COMPACT BATHROOM. SHOWER, TOILET AND WASHBASIN IN THE SAME ROOM.

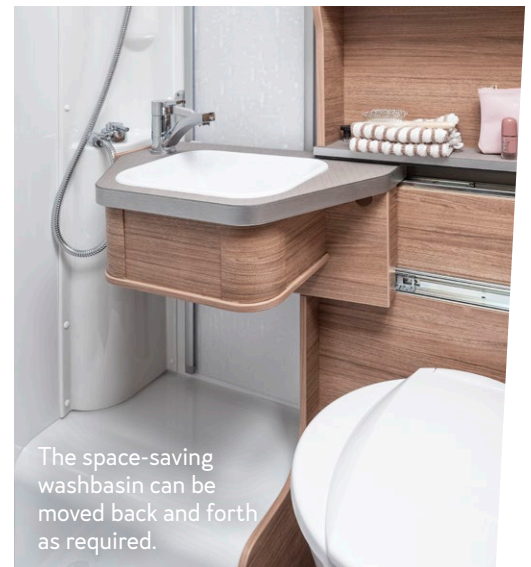

The space-saving washbasin can be moved back and forth as required.

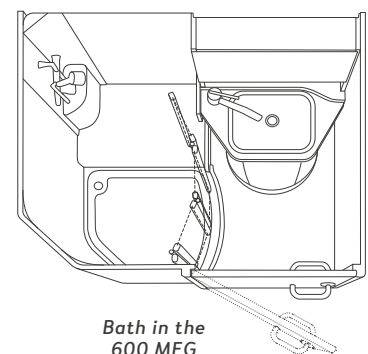

Bath in the 600 MEG

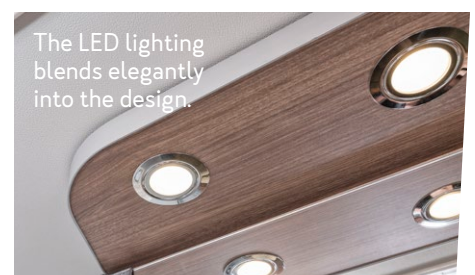

The LED lighting blends elegantly into the design.

**600 MEG** – Everything you need for refreshment combined in one room. With practical shower wall and aesthetic LED lighting.



Well thought-out bathroom concept in the **600 MF**. Toilet and shower are separated from the washbasin.

**LONGITUDINAL BATH. THE WASHBASIN IS OUTSIDE THE DOOR.**



Close the door and the water remains in the shower.

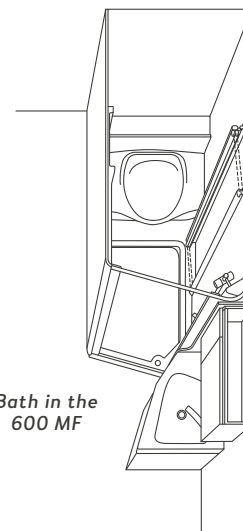

Bath in the 600 MF

**HIGHLIGHTS.**  
**CONVINCES WITH**  
**ELABORATE**  
**DETAILS.**



- 1. Hinged hood window.** The generous window with blackout and insect screen creates a light-flooded interior.
- 2. Typical van class.** The narrow body and the smaller vehicle width of 2.20 m offer excellent driving dynamics.
- 3. Folding worktop extension.** The practical extension with one-hand operation creates additional work surface.
- 4. Bed platform.** Inside there is additional storage space.
- 5. Easy-Travel-Box and bluuwater water filter.** All important service connections centrally combined in one place and hygienically clean water without chemicals.
- 6. KOMFORT body door as standard.** With automotive locking system, double seal and 2 foldable coat hooks.
- 7. More storage space at the 600 MF under the French bed.** The gas box is now installed in the wardrobe without any loss of storage space.

# LAYOUTS. TAILORED TO YOUR REQUIREMENTS.



**600 MEG**

**STRENGTHS:**

- Central dinette
- Longitudinal single beds
- Spacious rear garage
- 2 berths
- 4 belt-secured seats

Its space concept with comfortable single beds makes it ideal for anyone who appreciates comfort on the road.

**The manoeuvrable one with single beds.**



**600 MF**

**STRENGTHS:**

- Central dinette
- French bed
- 2 berths
- 4 belt-secured seats

Elegant detail, great effect. In combination with the French bed, the longitudinal bath provides more room to move in the living area.

**The compact one with chic.**



**5** YEARS  
SUCCESS  
STORY

OVER  
**20.000**  
HAPPY  
OWNERS

**1** OF  
HEARTS

NUMBER

**TOP**  
CUSTOMER  
SATISFAC-  
TION



GET SOME  
**[PEPPER]**  
INTO YOUR LIFE!

Not only hot, but also in great demand:  
the CaraCompact **EDITION [PEPPER]** is the number 1 of hearts.  
And it has been for over 5 years. When it comes to equipment and design,  
hardly any other model can keep up with it. That's why the **[PEPPER]**  
is not just bought, but loved and celebrated.  
The large community of the camping world knows what is good.







Send us your personal holiday photos with the CaraCompact **EDITION [PEPPER]** or tag your best moments on Instagram and become part of the #teamWEINSBERG.

#editionpepper

#teamWEINSBERG

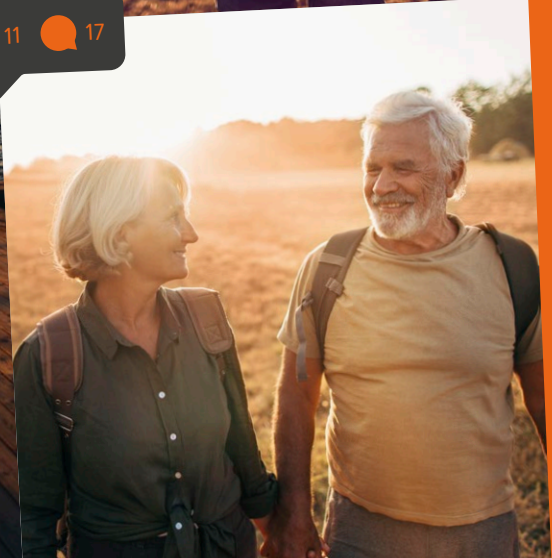
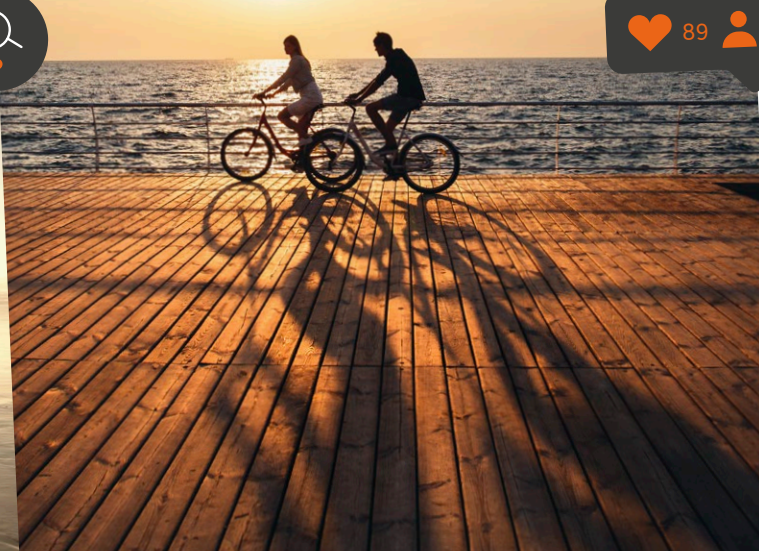

Durable: The exclusive Active-Line upholstery fabric MALBAR in artificial leather/fabric combination and special decorative stitching.

EDITION [PEPPER]



A real eye-catcher: the exterior trim in copper anthracite.

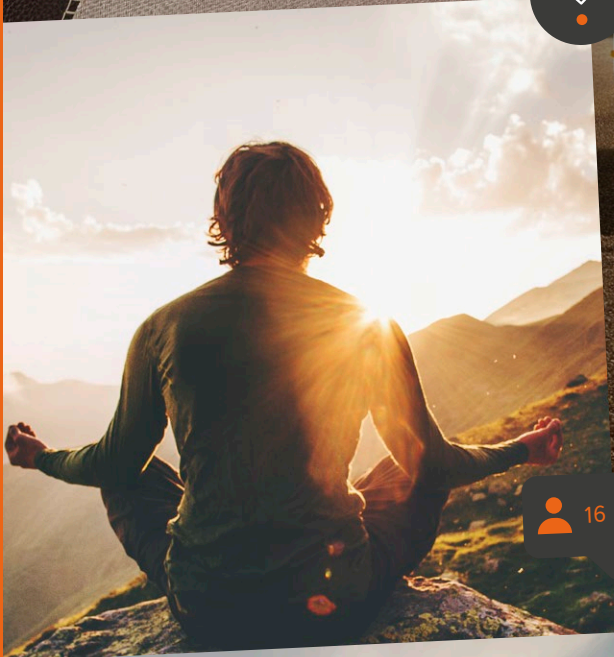

Always well protected: The standard awning makes your holiday even more enjoyable.



Well conceived: Storage compartments and ceiling cupboards with the exclusive WEINSBERG handles provide plenty of storage space.

Oyster complete antenna system: The standard SAT system ensures the best reception.

Big show: 24" SMART TV as standard in the TV package.



**CaraView** Insider knowledge



You can find the full extensive equipment from **CaraCompact EDITION [PEPPER]** at: [weinsberg.com/edition-pepper](https://weinsberg.com/edition-pepper)



Become part of the **EDITION [PEPPER]** community.

[@weinsberg\\_official](https://www.instagram.com/weinsberg_official)

[#teamWEINSBERG](https://www.instagram.com/teamWEINSBERG)

[#editionpepper](https://www.instagram.com/editionpepper)



# CaraLoft

**THE SEMI-INTEGRATED WITH  
THE LARGEST PAYLOAD.**

With 2.15 m headroom and a huge load capacity, the CaraLoft is a real loft for on the road. The sovereign semi-integrated offers plenty of space for great holiday experiences. Its concept makes it the ideal vehicle for couples and convinces with its outstanding feeling of space.

**A GENEROUS ALL-ROUNDER.**

# WEINSBERG

*Dein Urlaub!*



#team  
WEINSBERG

**Anne & Markus.** Finally a time out, finally on the go again! We have been looking forward to a few relaxing days for a long time. Our plan: to the foothills of the Alps with the CaraLoft. It always inspires us anew, because we can pack so much. After all, our trips are all about cooking and sports.

LOTS OF EQUIPMENT,  
LOTS OF ENERGY  
AND LOTS OF  
APPETITE.



WEINSBERG

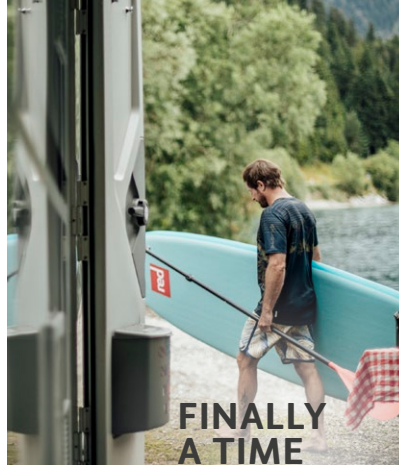

FINALLY  
A TIME  
ON THE GO.  
FINALLY  
OUT  
AGAIN.



**WITH 2.15 M  
HEADROOM  
THE CARALOFT  
OFFERS A  
UNIQUE FEELING  
OF SPACE.**



**650 MF**

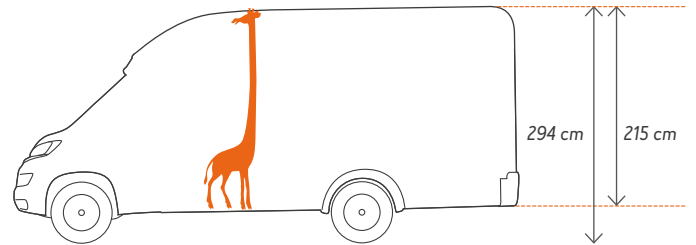

**650 MF**



With its unique feeling of space, the CaraLoft is the perfect companion for all those who like to travel with comfort and space. It offers an incredible amount of storage space for all kinds of holiday equipment and lots of well thought-out details. Thanks to its sporty driving dynamics, you always remain independent – there are no limits to your enjoyment.

**The 3 highlights:**

- Huge payload
- Continuous 2.15 m headroom
- Spacious rear garage

 up to 4 berths

 up to 5 belt-secured seats

 3 layouts

 under 3500 kg

**High-quality living atmosphere.** The CaraLoft impresses with plenty of storage space, well thought-out details and its high driving dynamics, even on bumpy terrain. It is the ideal camper for all those who like it compact but comfortable. With its special feeling of space and the modern interior design, the CaraLoft more than lives up to its name.



# OUR LOFT FOR ON THE ROAD.



The continuous side wall skirts in combination with the optionally available PREMIUM door – here at the **600 MF**.

## EASY-TRAVEL-BOX: ALL CONNECTIONS CENTRALISED IN ONE PLACE.

1. Cleaning opening for the fresh water tank
  2. Filling opening for fresh water tank
  3. Drain valves for fresh and grey water tank
  4. Protected electrical supply
  5. bluuwater water filter system.
- You can find more information on  
[» page 114.](#)





Great view from the driver's cabin – and intelligently placed storage compartments above.



Innovative LFI hood. Extremely stable and resistant.



**PACK IT  
ALL IN!  
A TRUE  
STORAGE  
MIRACLE.**



# UNIQUE FEELING OF SPACE.



# HUGE PAYLOAD.

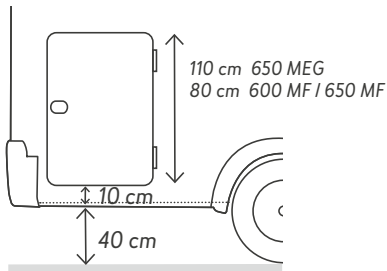

## LOW LOADING EDGE.

**Extremely comfortable.** You can really pack a lot into the CaraLoft. It scores with generous and unexpected storage options. The spacious rear garage is perfect for sports equipment and holiday gear, while the integrated side compartments keep things tidy. The low loading edge makes the rear garage particularly easy to load.

#team WEINSBERG

## Sports freaks also appreciate living comfort.

*What we particularly love about the CaraLoft? The ingenious storage options! In just a few easy steps we have everything we need for our day trips. And in the evening, a cosy ambience to relax in style.*



Storage space in the rear garage with one-hand operation.



**PLEASANT UNLOADING. SAVE YOUR POWER FOR SPORTS.**

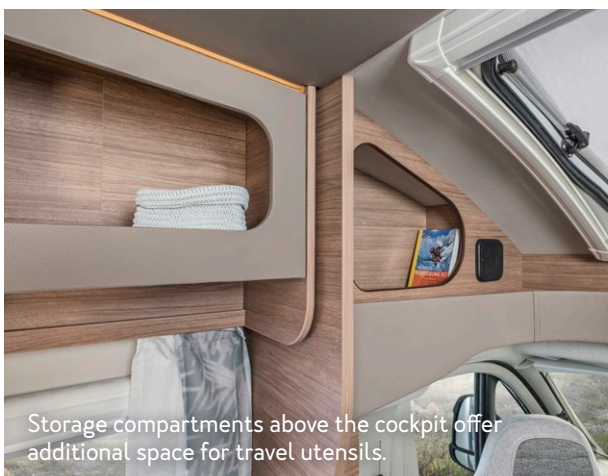

Storage compartments above the cockpit offer additional space for travel utensils.

## EVERYTHING READY TO HAND IN HANDY HIDEAWAYS.



**zzz SLEEPING**

**650 MF** – The French bed offers a particularly elegant room solution.



**FRENCH BED. INGENUOUS SOLUTION FOR RELAXING MOMENTS.**

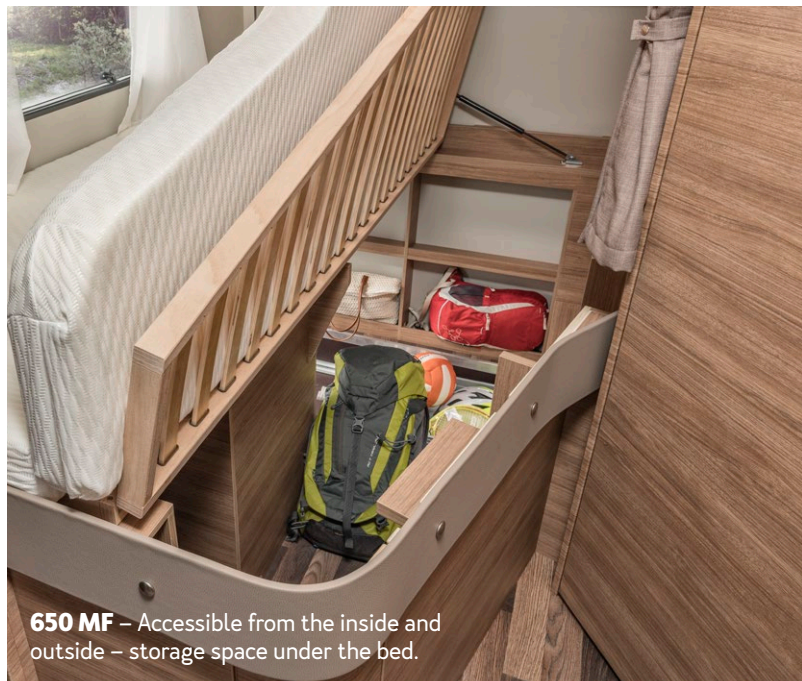

**650 MF** – Accessible from the inside and outside – storage space under the bed.

# PLENTY OF SPACE FOR GREAT HOLIDAY EXPERIENCES.



## Lots of space in the sleeping area.

The CaraLoft offers modern design, huge feel-good areas and easy-care fabrics. The standard EvoPore HRC mattresses ensure a healthy sleep.

#team WEINBERG

**Breakfast in bed.** If the weather doesn't want to play along, we recommend a Lazy Day in bed. The beds in the CaraLoft are big enough and comfortable!



**650 ME** – More comfort. The wardrobe under the bed.

## MAKE TWO OUT OF ONE.

Thanks to the optional bed extension, the two single beds can be converted into a large double bed in no time at all.

## LONGITUDINAL SINGLE BEDS. ENOUGH SPACE TO STRETCH OUT COMFORTABLY.



**650 ME** – Cosy single beds convince with best sleeping comfort thanks to EvoPore HRC mattresses in series.



**650 ME** – The balanced room concept invites you to cook and linger. The drawers with soft-close function provide additional operating convenience.

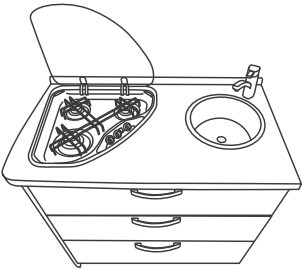

**A LOT OF ROOM TO MOVE ESPECIALLY WHEN COOKING.**

**Well equipped.** In the CaraLoft, you will find a fully-fledged kitchen with a 3-burner cooker plus glass cover, deep stainless steel sink and folding worktop. Thanks to functional elements such as the HPL kitchen back panels and the robust worktop, cooking is even more fun.



**Everything a cook needs on the road.** We have our own requirements when it comes to holiday catering, which the kitchen in the CaraLoft absolutely meets. My tip: Plan a meal with regional ingredients for your trip!



The 3-burner cooker with glass cover and the stainless steel sink invite you to cook.

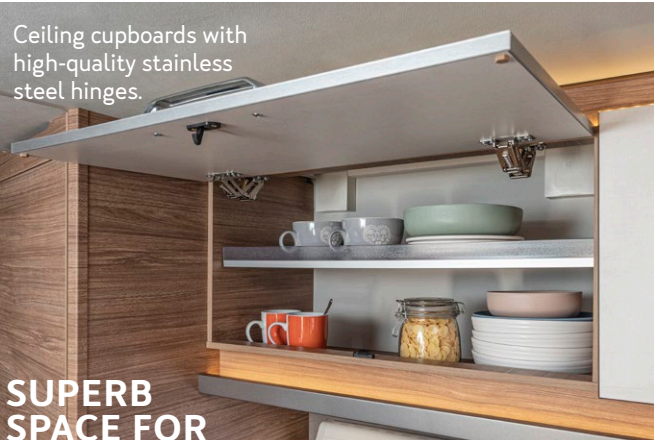

Ceiling cupboards with high-quality stainless steel hinges.

**SUPERB SPACE FOR INGREDIENTS AND COOKING UTENSILS.**

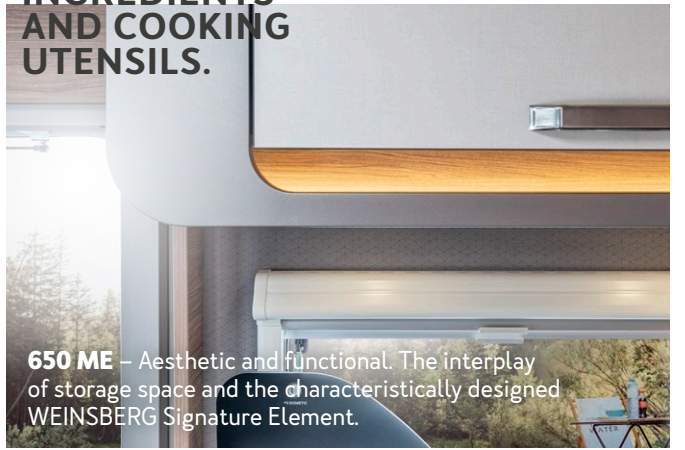

**650 ME** – Aesthetic and functional. The interplay of storage space and the characteristically designed WEINSBERG Signature Element.

## BALANCED ROOM CONCEPT.



**SWIVEL TABLE EXTENSION.**

**650 MF** – The rotatable original FIAT captainchair seats transform the dinette into a comfortable seating group [available in the FIAT Package].



**LONGITUDINAL  
BATHROOM,  
SHOWER ROOM  
DE LUXE.**

Plenty of space at the washbasin and in the shower – here in the **600 MF**.

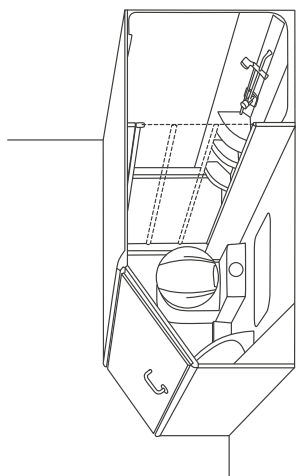

*Bath in the  
600 MF / 650 MF*

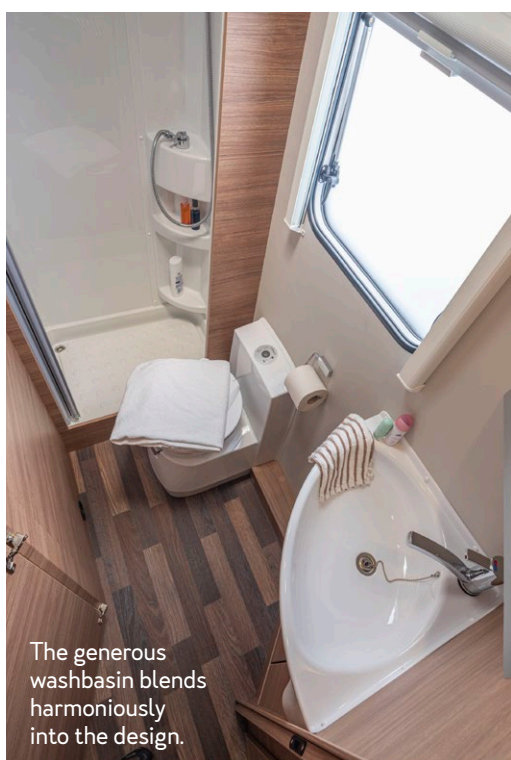

The generous washbasin blends harmoniously into the design.

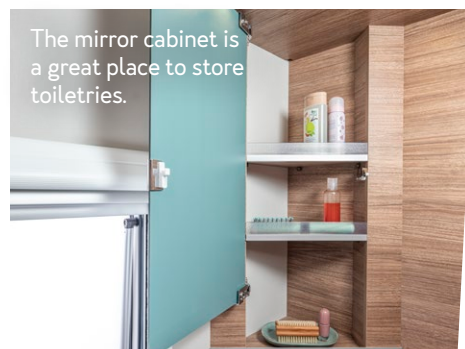

The mirror cabinet is a great place to store toiletries.



# PLENTY OF SPACE. HIGH COMFORT.

**Freshen up withroom to move.** The essentials count in the bathroom: Space, storage and refreshment. Well thought-out details such as the low shower tray entry ensure special comfort.

#team WEINSBERG

**Showering where we want.** What we love most about camping is the independence. Of course, we also take showers at campsites, but we really appreciate the flexibility that the bathroom on board gives us. And the bathroom in the CaraLoft is amazingly comfortable.



## COMPACT BATHROOM. STRAIGHTFORWARD AND CLEAR.

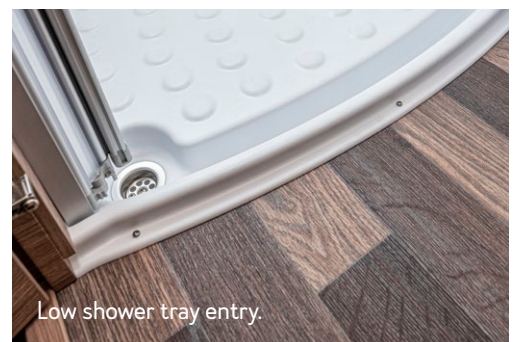
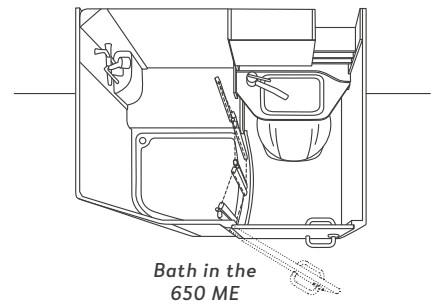

650 ME – The compact bathroom allows optimal use of space.

**HIGHLIGHTS.**  
**CONVINCES WITH**  
**ELABORATE**  
**DETAILS.**

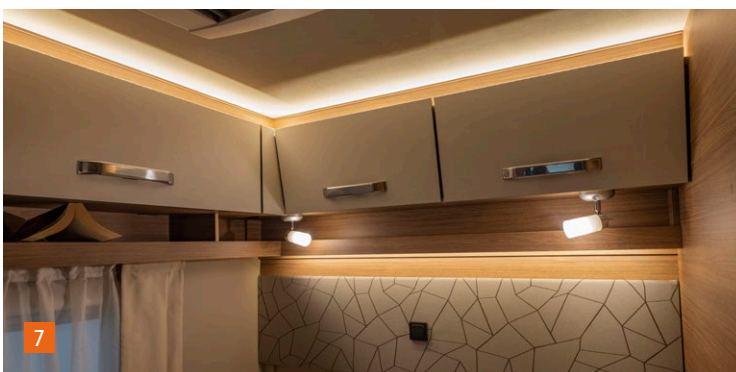

- 1. Swivel washbasin.** Can be positioned over the shower or toilet as required.
- 2. 133 l refrigerator with AES function.** Offers enough space for everything you need on vacation.
- 3. Body door PREMIUM with insect screen.** Keeps annoying guests out.
- 4. Storage space in the rear garage with one-hand operation.** The integrated compartments leave even more room for luggage.
- 5. Ceiling cabinets with high quality stainless steel hinges.** With many storage options for cooking utensils.
- 6. LFI hood.** Distinctive design and robust quality.
- 7. Ambient lighting.** Ensures a harmonious ambience in the living room.
- 8. Easy to reach gas valves.** Mounted in the upper cutlery drawer.
- 9. Longitudinally arranged gas locker.** Easy to reach and more headroom inside. (650 MF / 650 ME)

# LAYOUTS. TAILORED TO YOUR REQUIREMENTS.



**600 MF**

**STRENGTHS:**

- Central dinette
- French bed
- 2 berths
- 4 belt-secured seats

Compact layout with plenty of space to feel at home. Its French bed and the Vis-à-Vis kitchen offer comfortable space for two.

**The space talent with feel-good factor.**



**650 MF**

**STRENGTHS:**

- Central dinette
- French bed
- Up to 4 berths
- Up to 5 belt-secured seats

Its special features are the large longitudinal seat in the dinette and the central kitchen with an open feeling of space.

**The all-rounder with homely flair.**



**650 ME**

**STRENGTHS:**

- Central dinette
- Longitudinal single beds
- 2 berths
- 4 belt-secured seats

Here everything revolves around comfort. With comfortable single beds and a spacious kitchen solution. No other model offers more space in the sleeping area!

**The generous one with space for connoisseurs.**





#team  
WEINSBERG

**Peter, Paul and parents.** Others go island hopping, we take a road cruise! We cruise around with our CaraSuite and can easily go anywhere we want. Our road cruiser is great for that, because we even have separate bedrooms and have enough space for our toys. I want to go to the wilderness, my brother wants to go to the PLAYMOBIL Funpark and Dad really wants to show us the Auserland. Mom just wants to be with us. We're all looking forward to this trip.

WEINSBERG

*Dein Urlaub!*



# CaraSuite

**THE SEMI-INTEGRATED  
WITH LIFTING BED AND  
MAXIMUM HEADROOM.**

With its ingenious headroom and the practical lifting bed, the CaraSuite offers plenty of space for great holiday experiences. Its many sleeping possibilities and cosy ambience make it the ideal family or multi-generation vehicle.

**A COMFORTABLE SIZE.**





EVERYTHING  
FITS IN THERE  
MY DAD  
SAYS.



VERY COOL  
A STREET  
CRUISE LIKE  
THAT.



700 ME

## THE IDEAL FAMILY OR MULTI-GENERATION VEHICLE.

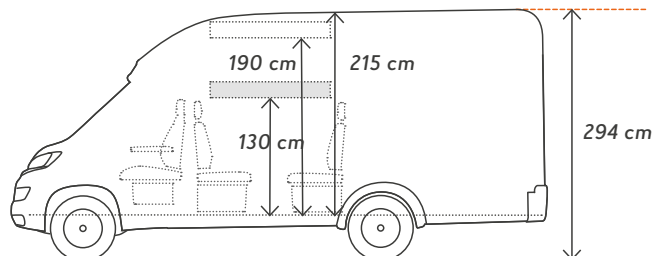

700 ME



With its cuddly lifting bed, the CaraSuite is perfect for a fun family trip. During the day it is safely stowed away, in the evening it is lowered in a jiffy. Plenty of space and a remarkable room height provide travel comfort for the young and the old.

### The 3 highlights:

- Standard lifting bed
- 2.15 m headroom
- Compact 2+2 motorhome



up to 6 berths



up to 5 belt-secured seats



3 layouts



under 3500 kg

DYNAMIC  
SILHOUETTE.  
GREAT OPTICS.



The characteristic design of the CaraSuite is further emphasised by the alloy rims and the spoiler lip in aluminium look – here on the **650 MG**

HUGE  
REAR GARAGE  
FOR EVEN MORE  
STORAGE SPACE.

Depending on the layout, 2 types of rear garages offer plenty of space for travel utensils - here in the **650 MG**.

650 MF  
1,98 m<sup>3</sup>

650 MG / 700 ME  
2,26 m<sup>3</sup>







**A HUGE LIFTING BED.  
HARD TO  
BELIEVE FROM  
THE OUTSIDE.**

**The semi-integrated with lifting bed.** The CaraSuite offers the perfect combination of travel and sleeping comfort. It's compact on the outside, but huge on the inside: the semi-integrated with the largest headroom offers plenty of room to move. Its many sleeping options and cosy ambience make it the ideal family or multi-generation vehicle.



**Looks good and has good driving dynamics.**  
And that with an interior height of 2.15 m!

# PLENTY OF SPACE FOR HOLIDAY EXPERIENCES.



All around a typical WEINSBERG – its characteristic design is also given by the taillight carrier with full LED taillights – here on the **650 MF**. You can also see an optional THULE bicycle carrier for up to 4 bicycles.

COMFORT  
TO  
LOWER.



REAL  
FEEL-GOOD  
AMBIENCE.

The pleasant atmosphere in the CaraSuite is created by the great standing height, the generous dinette and the stylish lines – here in the **650 MF**

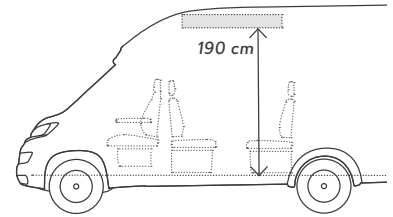

During the day, the lifting bed fits elegantly into the room concept and offers enough space to linger in the dinette.

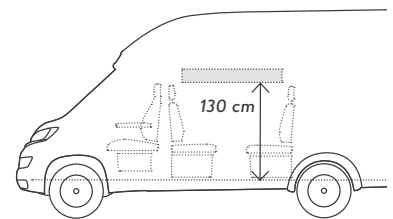

Super practical: Simply fold down the lifting bed to create a second, comfortable bed.

**A play paradise by day, a sleep paradise by night.** The lifting bed can be stowed under the high roof in a few easy steps. This means that the space underneath can be used perfectly at all times - and at the same time you can enjoy a comfortable standing height and plenty of headroom. A semi-integrated can be so flexible!

#team  
WEINSBERG

**Our own room.** My brother and I watch series together "upstairs" in our lifting bed. Mum and dad leave us alone - the open bathroom door closes the corridor and our family has two separate rooms.

**60 CM HEIGHT IN THE LIFTING BED. ENOUGH SPACE TO SLEEP AND RELAX.**

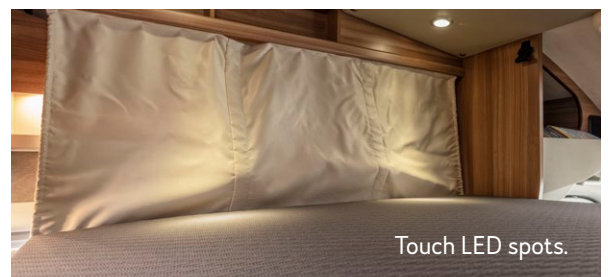

Touch LED spots.

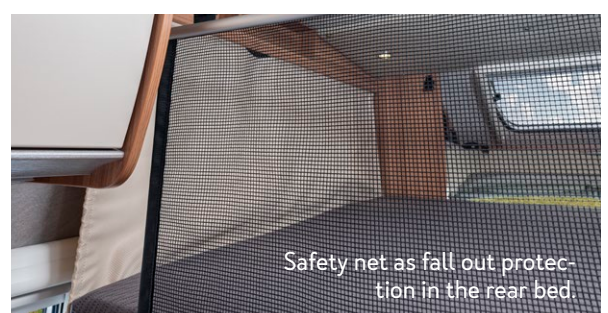

Safety net as fall out protection in the rear bed.

**700 ME** – Two generous single beds which can be combined to form a double bed by means of the roller slatted frame. The EvoPore HRC mattresses are on board as standard.



**LONGITUDINAL  
SINGLE  
BEDS.  
QUITE  
WIDE.**

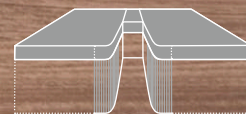

700 ME

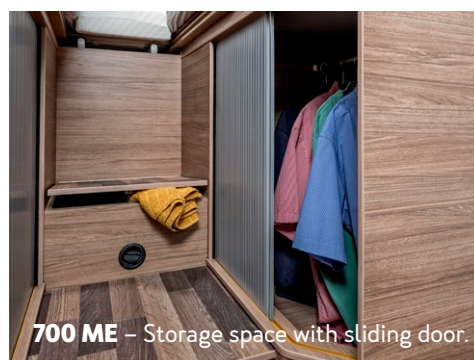

700 ME – Storage space with sliding door.

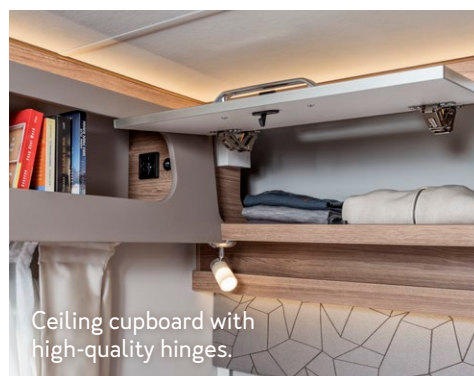

Ceiling cupboard with high-quality hinges.



## TRANSVERSE DOUBLE BED. PRACTICAL AND COSY.



**Camping holidays for all.** In the CaraSuite you can choose between three sleeping options and bed types in the rear. Parents can relax and recharge their batteries in the comfortable rear beds, while the kids can turn night into day in the lifting bed.

#team  
WEINBERG

**Everything that is important.** In the CaraSuite, we can take as many toys as we want without being told, "There's no room for that in the suitcase." That's really great! We spread our books and toys all over the bed and no one bothers.

**650 MG** – The transverse double bed uses the entire width of the vehicle and invites you to linger.

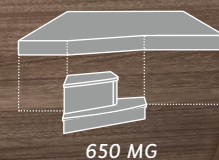

## GOOD SLEEP GUARANTEED WITH THREE BED TYPES.



## FRENCH BED. PARTICULARLY ELEGANT ROOM SOLUTION.

**650 MF** – The French bed with extra storage space.

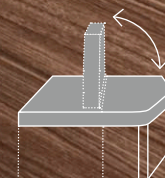

650 MF



## VIS-À-VIS KITCHEN. GREAT KITCHEN CONCEPT.

The great kitchen concept in the CaraSuite offers plenty of space for cooking and preparing – here in the **650 MF**.

*Unique room width.  
Between kitchen block  
and refrigerator.*

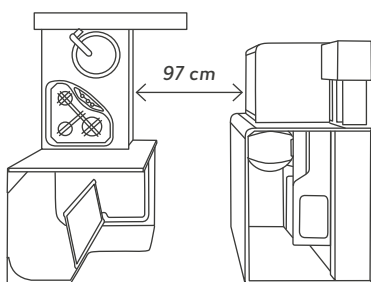

Practical: 3-flame cooker and stainless steel sink in the kitchen.



The 133 l refrigerator offers space for everything a family needs on holiday.

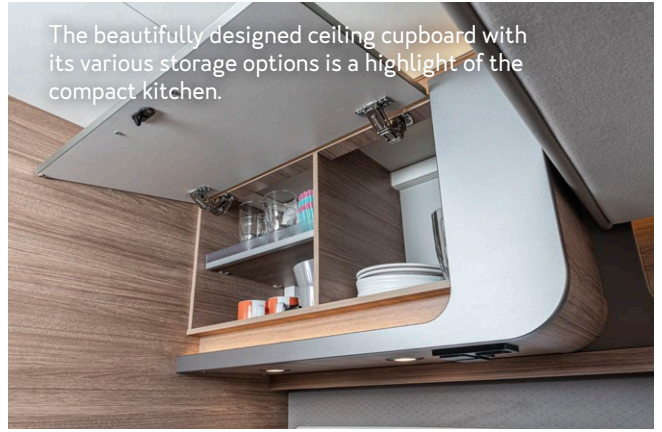

The beautifully designed ceiling cupboard with its various storage options is a highlight of the compact kitchen.

**More storage space, more enjoyment.**

The Vis-à-Vis kitchen in the CaraSuite is equipped for long family trips and journeys and offers enough possibilities to provide everyone with delicious meals. You can also use the wide kitchen unit à deux - for a perfect division of labour and more cooking fun.



**Everything that is important.** We banished the parents outside to surprise them with a special meal. Open the fridge, get out the pots, chop the vegetables, prepare the pasta: in our kitchen in the CaraSuite we have enough space for perfect teamwork when cooking.

# UNIQUE FEELING OF SPACE.



**SPACE FOR UP TO 6 PEOPLE THANKS TO THE LONGITUDINAL BENCH.**

Up to 6 people can be seated in the cosy dinette thanks to the optional rotating FIAT captainchair seats and the longitudinal side seat.

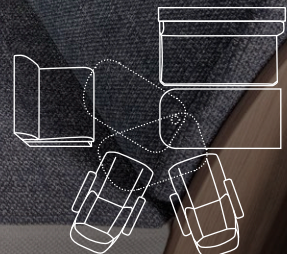

**700 ME** – Shower and toilet with washbasin are separated from each other so that the areas can be used by two people at the same time.



**SEPARATE BATHROOM.  
THE MOST  
GENEROUS  
SOLUTION.**

*Bath in the  
650 MG / 700 ME*

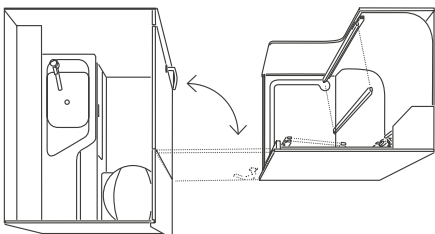

The cover for the shower tray creates additional living space. A comfortable entrance is guaranteed thanks to the low shower tray.



Spacious shower area with practical shower screen.



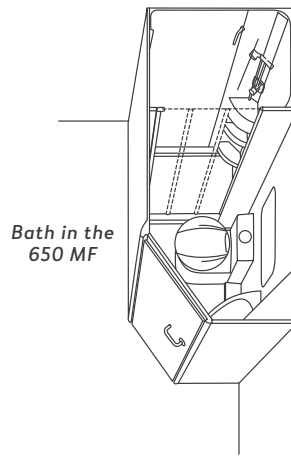

**Versatile, beautiful and practical.** The bathroom in the CaraSuite is the perfect place for a relaxing start or end of the day. It can even be used by two people, has hard-wearing surfaces and lots of storage options. Simply well planned and perfectly implemented.

#team WEINBERG

*This makes brushing teeth fun. We can also fool around in the bathroom, because there's plenty of room. And if one of us wants to be left alone while brushing his teeth, he gets into the shower because you can close the door there.*

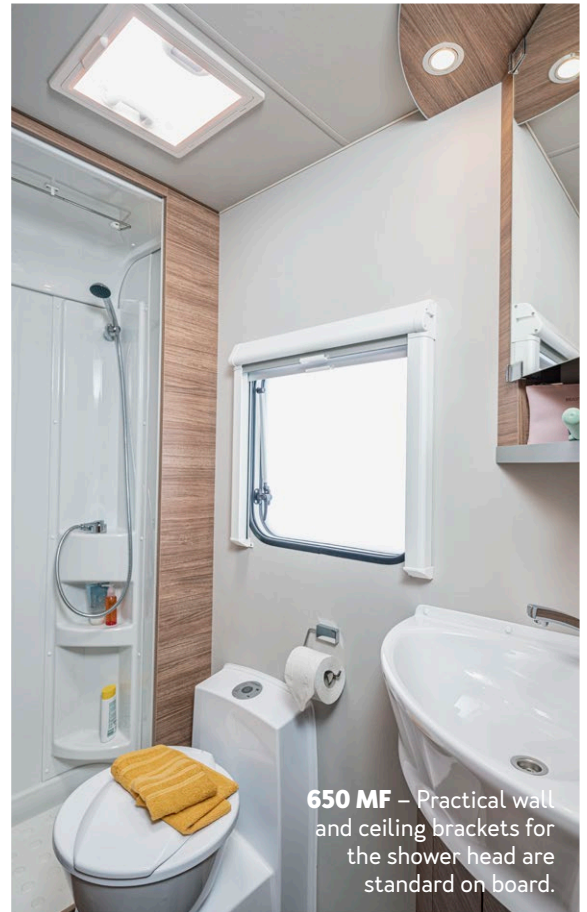

**650 MF** – Practical wall and ceiling brackets for the shower head are standard on board.

# EVERYTHING HERE REVOLVES AROUND SPACE.

**LONGITUDINAL  
BATH.  
AMAZING  
ROOM TO  
MOVE.**

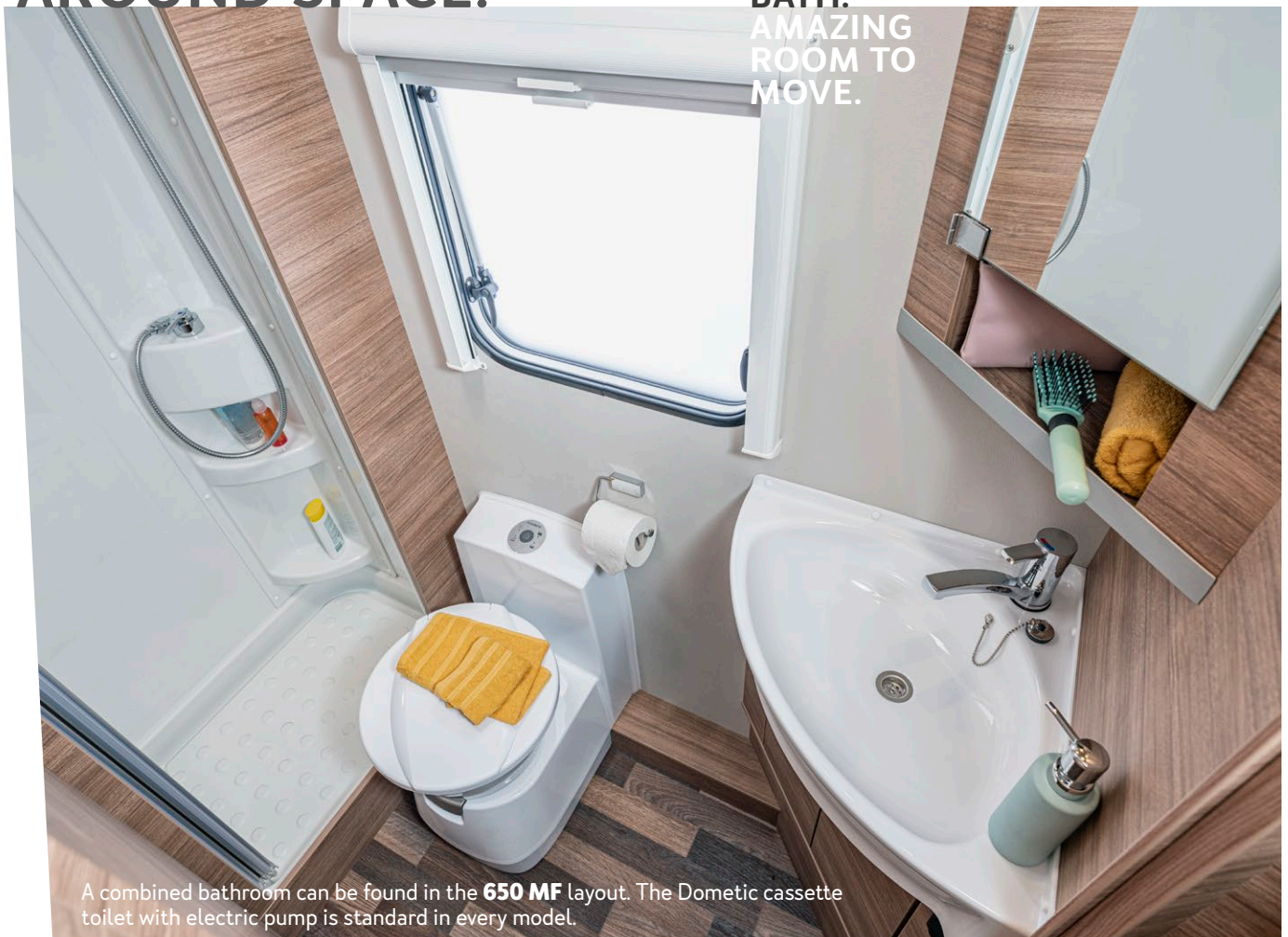

A combined bathroom can be found in the **650 MF** layout. The Dometic cassette toilet with electric pump is standard in every model.

# HIGHLIGHTS. CONVINCES WITH ELABORATE DETAILS.



2



1



3



4



5



6



7

**1. Exceptional room height.** With a height of 2.15 metres, a real feel-good ambience is created.

**2. High-quality exterior foil graphics.** For a long service life and a cool look.

**3. Lighting.** The indirect lighting on the cupboards creates a warm ambience.

**4. Lifting bed with safety net.** Creates more sleeping places and offers safety on both sides due to the fall-out protection (nets).

**5. Storage compartment in leather.** Easily accessible storage space in cool leather look.

**6. Easy-Travel-Box.** Easy access to all service connections of the Easy-Travel-Box and the bluuwater water filter.

**7. Rear garage.** The spacious rear garage with one-hand operation ensures comfort when travelling.

**8. Unique room layout.** Offers enough space for the whole family.



8

# LAYOUTS. TAILORED TO YOUR REQUIREMENTS.



**650 MF**

**STRENGTHS:**

- Central dinette
- French bed
- Lifting bed in series
- 6 berths
- Up to 5 belt-secured seats

In combination with the French bed, the lifting bed provides space for well-being and room to move. An additional sleeping place can be created by connecting the dinette with the longitudinal bench.

**The family layout with six sleeping places.**



**650 MG**

**STRENGTHS:**

- Central dinette
- Transverse double bed
- Lifting bed in series
- Spacious rear garage
- 5 berths
- Up to 5 belt-secured seats

Here the bed is transverse and harmonises with the bathroom. The lifting bed and the vis-à-vis kitchen ensure optimum use of space.

**The spacious travelling companion.**



**700 ME**

**STRENGTHS:**

- Central dinette
- Longitudinal single beds
- Lifting bed as standard
- 5 berths
- Up to 5 belt-secured seats

Generous layout with lifting bed and plenty of storage space. Comfortable longitudinal single beds meet the practical spacious bathroom and offer room for the whole family.

**The versatile one with a sense of family.**



# CaraHome

## THE FAMILY-FRIENDLY ALCOVE WITH OUTSTANDING SPACE.

With its alcove and the well thought-out room division, the CaraHome offers enough space for beautiful travel experiences. Depending on the layout, its home accommodates between 4 and 6 berths.

### MOBILE FAMILY HOME.





#team  
**WEINSBERG**

**Christian, Anja, Tobias & Paula.** We love our family trips with the CaraHome. And the winter. Why not combine the two? So we spend a weekend together in the snow. When it's cold, it's especially cosy in the CaraHome - after all, it's suitable for winter.

In general, our stay in the CaraHome is very relaxed, our WEINSBERG is simply perfect for family holidays. Wet winter clothes? No problem, they dry them in the bathroom. Taking everything with you that makes life better? No problem, we even have our camping table and chairs with us to sit in the sun in between. The cross-country skis and snowshoes have just as much room as the camping grill.

CHILL OUT  
AT COOL  
TEMPERATURES.



OUR COSY  
HOME  
IN THE  
SNOW.

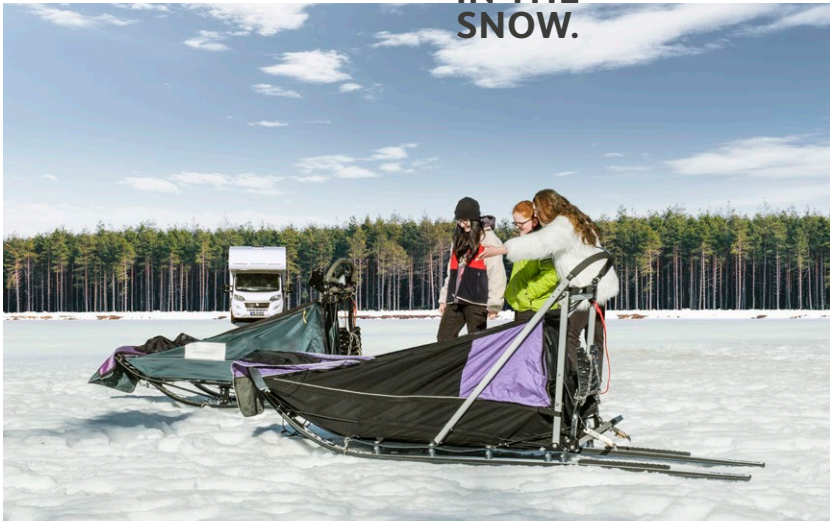

**SPACE FOR EVERYONE.  
AND FOR LOTS OF LUGGAGE.**



**600 DKG**

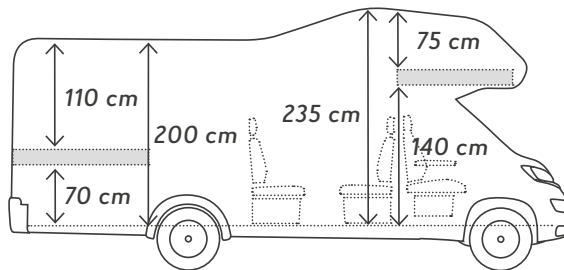

**650 DG**

**NEW**



Imagine never having to book a room again. Imagine finding a roomy apartment anywhere in the world. Imagine having your home with you wherever you go. Discover the family-friendly alcove with outstanding space now.

**The 3 highlights:**

- SUPERLIGHT technology (650 DG)
- Huge storage space
- Two separable sleeping areas

 up to 6 berths

 up to 6 belt-secured seats

 4 layouts

 under 3500 kg

**A motorhome for the whole family:** with a classic alcove construction, two separate sleeping areas and space for up to six people. The CaraHome owes its sleek appearance to its sophisticated chassis, modern architecture and stylish exterior design. The big one is really worth seeing!



# YOUR MOBILE FAMILY HOME ALWAYS WITH YOU.



The optional Styling Package FIAT ensures great looks and travelling with style – here at the **650 DG**

**THE ALCOVE.  
NO OTHER  
MOTORHOME  
FLIES HIGHER.**

Enjoy the best view at the top in the fresh air. The roof window in the alcove makes the interior feel even more spacious and open.





**SPACIOUS  
REAR GARAGE.  
EVEN A BICYCLE  
FITS IN THERE.**

550 MG  
2,13 m<sup>3</sup>

600 DKG  
2,26 m<sup>3</sup>

650 DG  
2,39 m<sup>3</sup>

650 MEG  
2,39 m<sup>3</sup>



Four types of rear garages offer the right storage space for every kind of luggage - here in the **600 DKG**.



**UP TO 6  
BELT-SECURED  
SEATS.**

In the **600 DKG** and **650 DG**, families not only find six berths, but also the matching number of seats with seat belts. Thanks to the revolutionary SUPERLIGHT technology in the **650 DG**, even more luggage can be loaded for all family members.



## SUPERIOR FEELING OF SPACE.

The enormous room height is typical for the alcove design and creates a very special feeling of space. The sleeping area almost looks like a second storey. The new interior design is a real eye-catcher and enters into an ingenious interplay with the handleless push-to-open furniture flaps – here in the **600 DKG**.

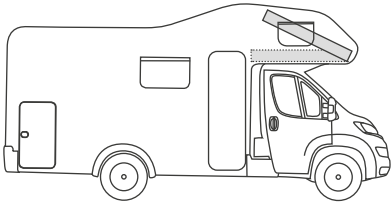

**Folding alcove bed as an option.** For even more headroom in the cab.

## UPPER FLOOR: A RETREAT.



Alcove. Cozy sleeping place with optional heating. Flooded with light during the day, brilliantly illuminated at night.



**More space in the loft bed.** The CaraHome hides a huge double bed in its spacious alcove hood. This sleeping place is so cosy that everyone just wants to have it to themselves.



**The ideal children's room.** It's clear that children love the alcove. But be surprised how peacefully and harmoniously siblings share this retreat. The two additional USB sockets mean there are no discussions about whose mobile phone is allowed to charge. And there's plenty of space in the alcove anyway.

## ALMOST LIKE YOUR OWN ROOM.



Easy accessible shelves.

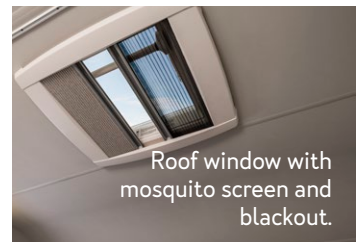
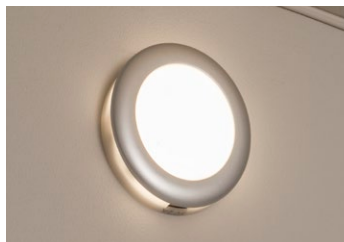

Roof window with mosquito screen and blackout.



**TRANSVERSE  
DOUBLE BED.  
LARGE BED  
DIMENSIONS.**

In the spacious double bed, the standard EvoPore HRC lightweight mattress ensures a restful and comfortable sleep – here in the **650 DG**.

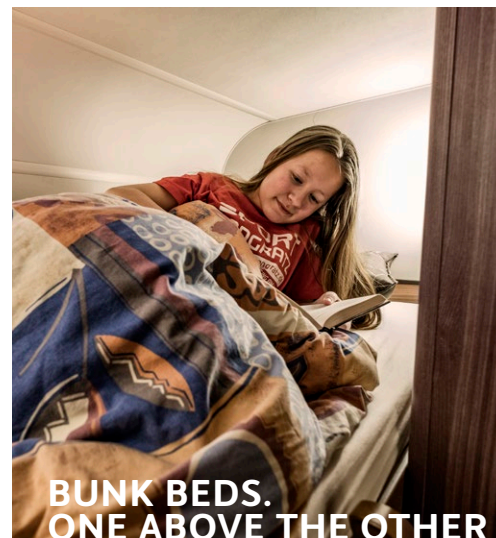

**BUNK BEDS.  
ONE ABOVE THE OTHER  
INSTEAD  
OF SIDE BY SIDE.**



The bunk bed including standard safety net in the **600 DKG** layout is ideal for children. Particularly well thought-out: with this model, access to the rear garage is also possible from the inside.



In the twinkling of an eye, the dinette becomes an additional sleeping place.

## THE RIGHT SLEEPING PLACE FOR EVERYONE.

**Fantastic choice.** Whether as a couple, with one or more children, thanks to the large variety of beds, both young and old feel really comfortable when sleeping.

#team WEINSBERG

**Good night.** As a real family motorhome, the CaraHome also offers a layout with a bunk bed, the 600 DKG. This is a particular advantage when travelling with children. While one of them uses the individually adjustable bed light for reading, the other one already has it pleasantly dark to fall asleep.

**BED VARIETY.  
HERE EVERYONE  
FINDS THEIR  
SLEEPING PLACE.**

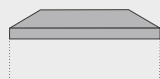

Transverse double bed

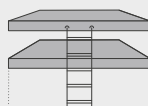

Bunk bed



Alcove bed

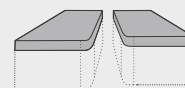

Longitudinal single beds



**DINETTE WITH 4 BELT-SECURED SEATS.**

The dinette in the **600 DKG** and **650 DG** offers four belt-secured seats. Hard-wearing fabrics and cosy seating comfort guarantee a relaxed get-together.



**DINETTE WITH SWIVEL CAPTAIN CHAIR SEATS.**

The dinette is space-saving and flexible thanks to the swivelling captain-chair seats. If necessary, four people can sit here.

**The right thing for every taste.** The CaraHome stands for variety and this is also reflected in the selection of kitchens, refrigerators and dinettes. From flexible to large, each layout has its particular advantages.

**#team WEINSBERG** **Table manners.** During the meal, the cup holder secures the drinks. Even though the robust fabrics of the dinette would be easy to wipe clean, you don't necessarily have to test it...

The pleasant lighting concept creates the right atmosphere. The worktop extension offers enough space for cooking together – here in the **650 DG**.

Open the doors for huge storage space.

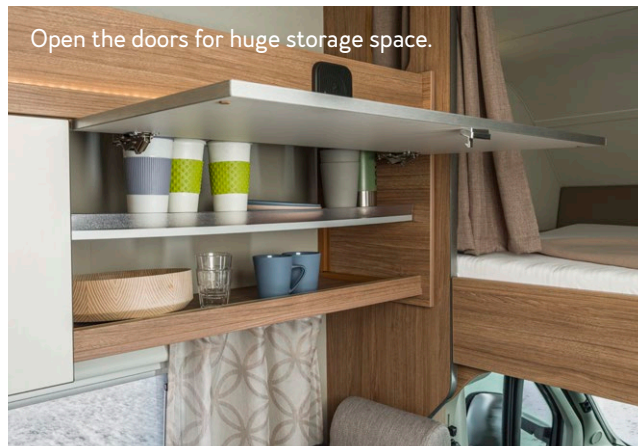

# EVERYONE LIKES TO BE TOGETHER HERE.

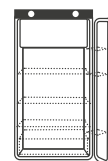

Refrigerator  
106 l  
standard 550 MG

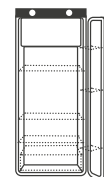

Refrigerator  
142 l  
standard 650 MEG

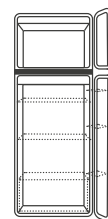

Refrigerator  
177 l  
standard 600 DKG /  
650 DG

Kitchen drawer with soft-close function and practical compartments.

COMPACT,  
COMPLETE.  
THIS IS WHERE  
TRUE GREAT-  
NESS SHOWS  
ITSELF.

**SIMPLY  
ELABORATE.**

The compartments integrated into the wall are eye-catching and provide storage space – here in the **600 DKG**.



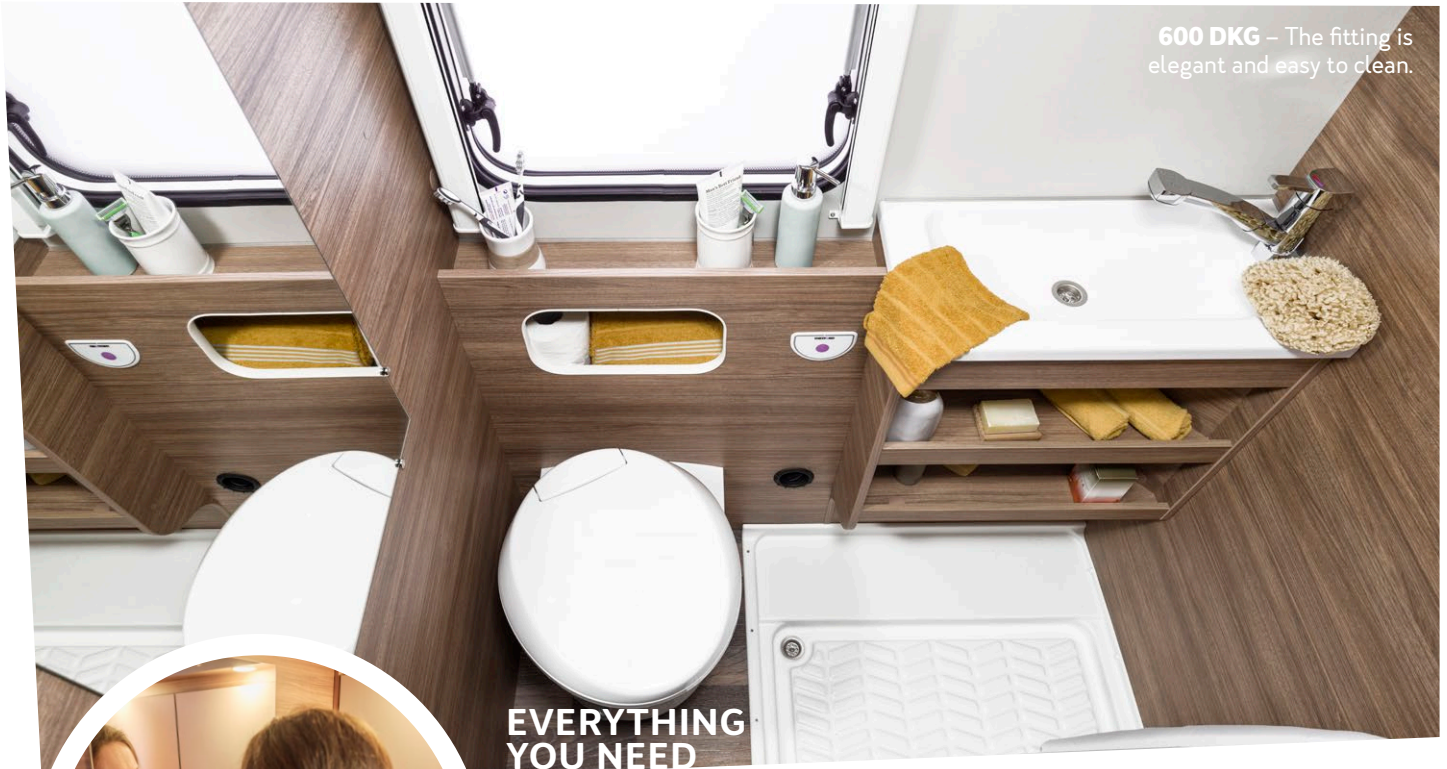

600 DKG – The fitting is elegant and easy to clean.



**EVERYTHING YOU NEED FOR A JOURNEY OF DISCOVERY.**

**Ingeniously planned.** Optimal use of space thanks to compact design. And with the many practical details, you feel at home when you freshen up with lots of storage space on top.

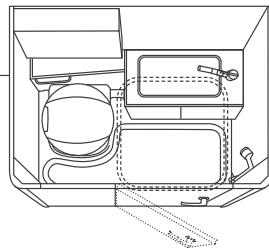

#team WEINSBERG

**That feels good.** What do you wish for after an intense day in the fresh air? Warm feet, a cosy towel and a hot shower. In the pleasant atmosphere of your own CaraHome? Even better.

Bath in the  
550 MG / 600 DKG /  
650 MEG / 650 DG



Shower head with a pleasant water jet.



550 MG

**SLIDING WASHBASIN. FOR LOTS OF ROOM TO MOVE.**

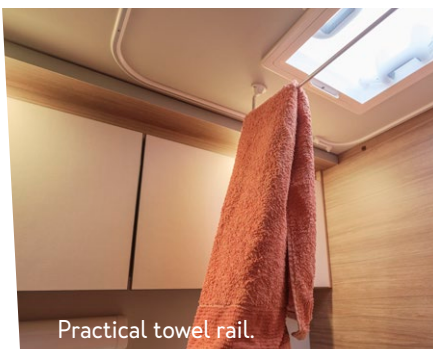

Practical towel rail.

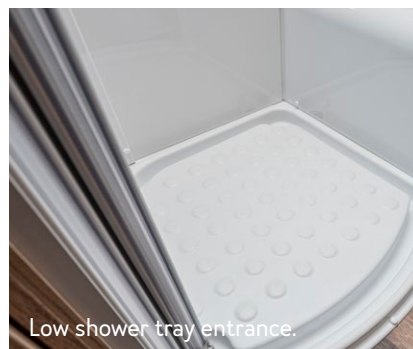

Low shower tray entrance.

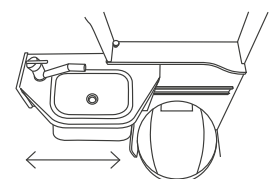

# HIGHLIGHTS. CONVINCES WITH ELABORATE DETAILS.

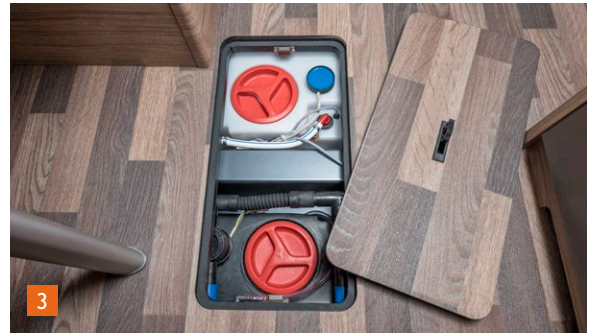

- 1. Alcove.** The Alcove is a real cuddling cave with an optional heating.
- 2. Handleless push-to-open cupboards.** Ensure modern, elegant design in the interior.
- 3. Fresh and grey water tanks.** The easy cleaning of the fresh and grey water tank is also possible from the inside of the vehicle.
- 4. Soft-close functions.** The spacious drawers close quietly and pleasantly.
- 5. Central control panel and the new TRUMA iNetX system.** One look is all it takes to check the water level, electronics supply and heating.
- 6. Spacious rear garage with one-hand operation.** Accessible through the outside flap and the living room.
- 7. Separate gas locker.** Easy access via the service door in the side wall.
- 8. Everything in its place.** Central and easily accessible control of the fresh water/grey water tank as well as water filter, frost valve and power connection.
- 9. SUPERLIGHT technology (650 DG).** An increase of almost 30% additional payload - More information on [»page 112.](#)

# LAYOUTS. TAILORED TO YOUR REQUIREMENTS.



**550 MG**

**STRENGTHS:**

- Central dinette
- Transverse double bed
- Alcove bed
- Spacious rear garage
- 4 berths
- 4 belt-secured seats

Compact dimensions and yet fully geared to the family. The shortest alcove with transverse double bed and plenty of storage space in the rear garage.

**Space miracle with room for family holidays.**



**600 DKG**

**STRENGTHS:**

- Dinette
- Children's layout - Double bunk bed
- Alcove bed
- Spacious rear garage
- 6 berths
- 6 belt-secured seats

A true children's layout with bunk bed and plenty of storage space. The separate sleeping areas serve as retreats for young and old.

**The cosy family friend.**



**650 DG**

**NOW NEW SUPERLIGHT-TECHNOLOGY**

*You can find more information on page 112.*

**STRENGTHS:**

- Dinette
- Transverse double bed
- Alcove bed
- Spacious rear garage
- 6 berths
- 6 belt-secured seats

Its special feature is the spacious layout with a seating area for four in the cosy dinette, spacious kitchen and comfortable transverse double bed.

**The super-light six-person home with plenty of load capacity.**



**650 MEG**

**STRENGTHS:**

- Central dinette
- Longitudinal single beds
- Alcove bed
- Spacious rear garage
- 5 berths
- 4 belt-secured seats

Plenty of space with comfortable longitudinal single beds and a large rear garage for relaxed travel experiences.

**The payload champion with sleeping comfort.**





# CaraCore

**THE FULLY INTEGRATED  
WITH SUPERIOR EQUIPMENT  
AND PRESENCE.**

It skilfully combines utility with design.  
Dynamics and high quality are in his blood.  
100% strong appearance, 100% WEINSBERG DNA.

**STYLE-CONSCIOUS TRENDSETTER.**

# WEINSBERG

*Dein Urlaub!*



#team  
WEINSBERG

**Rudi & Gerlinde.** We are already old hands at camping. What is new, however, is our CaraCore, which we are taking out for the first time this year - but properly! Our favourite destination Norway is on the itinerary. Without any time limit, but at a time of the year where more locals than tourists are around. From Bavaria we drive along the fjords up to the Lofoten. Completely according to our own rhythm and with a sense of style. After all, the CaraCore shines with its outstanding design and fits perfectly to Scandinavia.



A TOAST TO  
ACTIVE  
COMFORT!

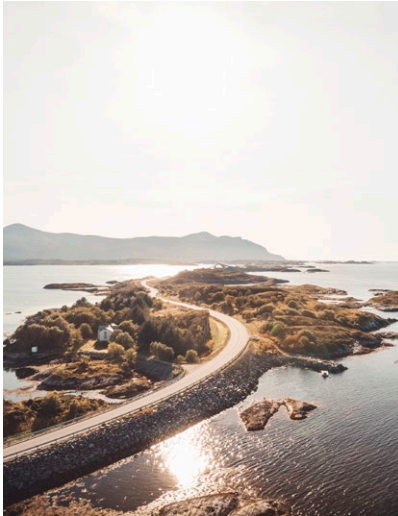

LESS  
RUSHING  
MEANS  
MORE  
ENJOYMENT.



650 MEG

100%  
WEINSBERG  
DNA



FUNCTIONALITY  
AND DESIGN  
COMBINED.

700 MEG



The CaraCore loves understatement and thus shows presence. It skilfully combines utility with design. An impressive interplay of feeling of space, high-quality materials and exceptional driving comfort.

**The 3 highlights:**

- Dynamic progressive design
- Full-LED headlights
- Lifting bed in series

 up to 5 berths

 up to 5 belt-secured seats

 3 layouts

 under 3500 kg

**The fully integrated WEINSBERG.** WEINSBERG's many years of experience come to take effect in the CaraCore. Enormous precision is found here in the smallest details. The CaraCore combines all the advantages of a fully integrated with a unique appearance. The demands on the design of the CaraCore are deliberately set high: independent, characteristic, present and powerful. This is evident in the clean lines, clear edges and exciting surfaces. It is the better semi-integrated with lifting bed.



# SURPRISINGLY DIFFERENT. FULLY INTEGRATED.

Characteristic LED headlights, optional aluminium rims in the exclusive WEINSBERG look and the optional Styling Package underline the appearance of the CaraCore – here on the **650 MEG**.



**PURE AESTHETICS MEETS PRACTICAL USE.**



**A question of style.** The optionally available EXKLUSIV body door impresses with its 70 cm width, the additional window and the coming-home lighting.

 You can find more information on page 104.



Dynamic. The side wall aprons with black inlay and the driver's door with electric step.



**PANORAMA  
WINDSCREEN  
FOR PERFECT  
ALL-ROUND  
VISIBILITY.**



Thanks to the huge panorama windscreen, the feeling of freedom in the CaraCore is incomparable. The perfect all-round visibility also ensures more safety on the road - here on the **700 MEG**.

**CLEAR LINES  
AND STRIKING  
DESIGN  
LANGUAGE.**



The striking taillight carrier with full-LED taillights and the optional 17" WEINSBERG alloy rims provide a dynamic design - here on the **700 MEG**.



**Quality that you see and feel.** Components made of LFI impress with optimal properties such as highest manufacturing precision. The maximum structural rigidity guarantees best safety. The LFI hood makes the CaraCore also an visual eye-catcher.

#team WEINSBERG

**A mobile dream home.** I still remember the words of our WEINSBERG dealer clearly. He spoke of a „completely new category of vehicle“. The CaraCore shows us every day anew how right he was with that.

**“STATE OF THE ART”  
FROM ITS APPEARANCE  
TO ITS PRICE-  
PERFORMANCE RATIO.**

Full LED reversing lights with WEINSBERG logo for good visibility and safety.



Strong in lighting, strong in optics: the full LED headlights in cube design.



Easy access to the gas bottles through the longitudinally arranged gas locker.



The integrated head-up display keeps the driver's eyes on the road. Optionally available in the Media Package.

**A CLASS OF  
ITS OWN.  
THE BETTER  
SEMI-INTEGRATED  
WITH LIFTING BED.**

**100%  
WEINSBERG  
DNA**

**GROUNDBREAKING  
DESIGN & HIGHEST  
PRECISION THANKS  
TO STATE-OF-THE-ART  
LFI TECHNOLOGY.**



**THIS IS ALSO  
A STATEMENT:  
LIFTING BED AS  
STANDARD FOR  
ADDITIONAL  
TRAVEL COMFORT.**

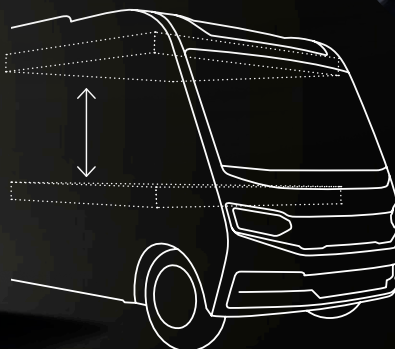

THE SENSE OF SPACE SHOWS TRUE GREATNESS.



The impression is absolutely magnificent and is supported by the elegant cross-grain of the furniture - here in the 700 MEG

## SIMPLY HUGE. OPEN LINES OF SIGHT.

**Beauty everywhere you look.** The fully integrated construction in the CaraCore gives you a unique feeling of space. With the open lines of sight, you always have all the highlights in view: the comfortable beds, the inviting kitchen and the cosy heart of every motorhome, the dinette.

#team WEINSBERG

**There's nothing like cosiness.**

The interior of the CaraCore looks like one big room, and the space in the dinette leaves nothing to be desired. It's almost as comfortable here as on the sofa at home.

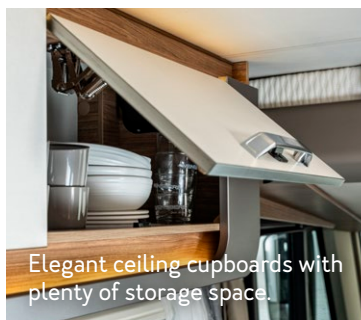

Elegant ceiling cupboards with plenty of storage space.

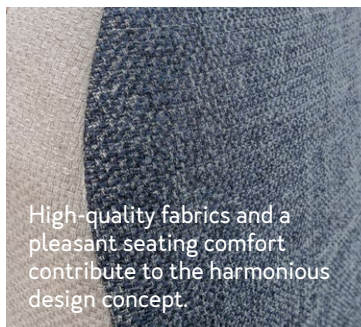

High-quality fabrics and a pleasant seating comfort contribute to the harmonious design concept.





**ERGONOMIC SWIVEL SEATS.**

Optional L-shaped dinette bench. The side bench and the fold-out seat are waiting for comfortable moments – here in the **700 MEG**.

**FLOWING TRANSITIONS CREATE A UNIQUE AMBIENCE.**



Huge. Open lines of sight create a unique feeling of space with a smooth transition between living area and driver's cab – here in the **700 MEG**.

700 MEG – The Vis-à-Vis kitchenette has internalised aesthetics.



**THE VIS-À-VIS  
KITCHENETTE  
HAS INTERNALISED  
AESTHETICS.**



Awesome. Slim Tower refrigerator with 142-litre capacity and AES function by which the energy type is automatically selected.



Silent. Spacious drawers with soft-close function.

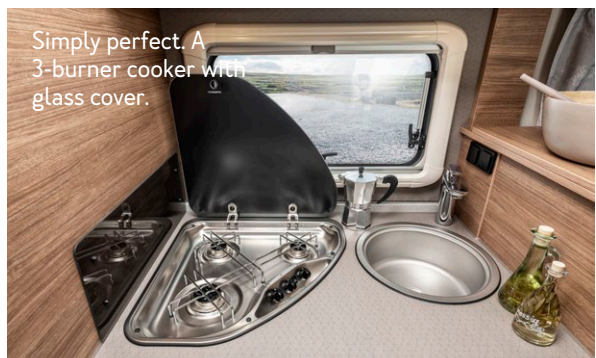

Simply perfect. A 3-burner cooker with glass cover.

# FINE SELECTION. DIFFERENT KITCHEN CONCEPTS.



## Perfect kitchen planning.

Room to move is everything in the kitchen and much more in the motorhome. The open flair in the CaraCore comes into its own here and enables enjoyable cooking for all the senses.

#team WEINSBERG

**The purest pleasure.** In all the years we've been camping, we've never had so much storage space. We use it particularly intensively in the kitchen. This means that we can also safely head for destinations where the nearest supermarket is a few kilometres away.



Formative. The characteristic WEINSBERG Signature Element.



## LONGITUDINAL KITCHEN. THE TIMELESS CLASSIC COMBINES UTILITY WITH DESIGN.



650 MEG – The kitchen block with the Signature Element fits perfectly into the room concept.



## A LIVING DREAM ON WHEELS.

The standard lifting bed fits elegantly into the room concept. When raised, there is enough space underneath to linger in the dinette – here in the **700 MEG**.



When the lifting bed is lowered, there is a cosy sleeping place for two people – here in the **700 MEG**.



## PLENTY OF SPACE WITH THE LIFTING BED LOWERED.

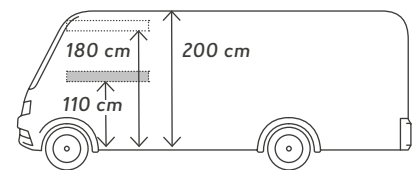

**The better semi-integrated with lifting bed.** The fact that the CaraCore carries the WEINSBERG values is shown in its space, family-friendliness and usability. Its special feature: the lifting bed is located above the driver's cabin and can simply be lowered when needed. So the dinette can also be used when someone is sleeping "upstairs".

#team  
WEINSBERG

*Sleep above, feast below.* A further advantage of the CaraCore is its lifting bed. Rudi likes to use it for a little afternoon nap while I enjoy a coffee in the dinette.



The raised lifting bed fits perfectly into the room concept.



Premium ambience with LED lights with touch function also in the lifting bed area.

Especially generous. The sleeping area in **650 MEG** and **700 MEG** with 2m long longitudinal single beds.



**LARGE BED DIMENSIONS FOR BIG TRAVEL DREAMS.**



Elegant cupboards with generous storage options



Reading spots for optimal lighting in the sleeping area.



Practical. The dinette can become an additional sleeping place.

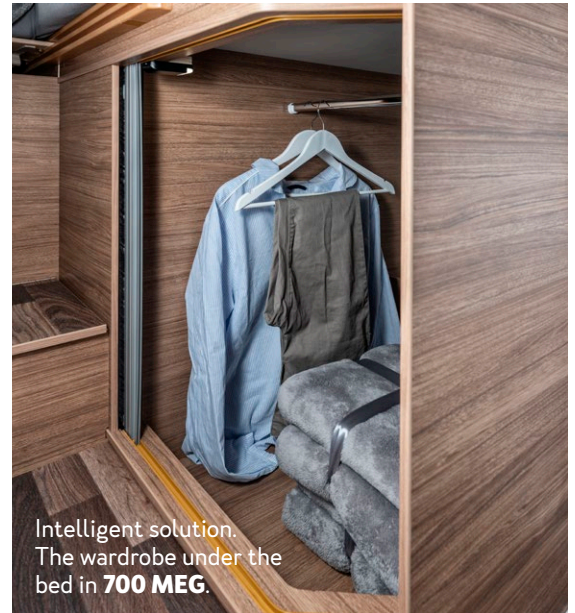

Intelligent solution. The wardrobe under the bed in **700 MEG**.

**Wonderful sleeping ambience.** Sleeping can also be stylish. High-quality details such as the indirect lighting create a harmonious flair in the CaraCore.

#team  
WEINSBERG

**Cosy retreat.** The huge sleeping place in the rear is incredibly comfortable. This is definitely my favourite place to relax, especially when I want to retreat a bit.

## THE COMFORT ZONES WITH PERFECT DESIGN.



**ELEGANT  
SPACE SOLUTION.**

**650 MF** – French bed with EvoPore HRC mattresses and storage space under the bed.

700 MEG – Elegant design in the largest separate bathroom in its class.

FRESHEN  
UP IN  
STYLE.



**BATHROOM.  
CLOSE THE DOORS  
TO THE LIVING AREA  
AND YOU HAVE A  
LARGE BATHROOM.**

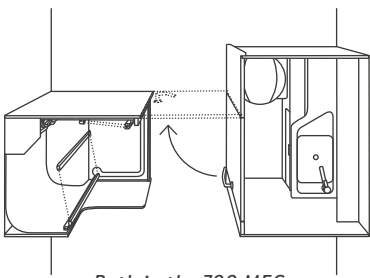

*Bath in the 700 MEG*



A mirror cabinet with elegant LED lights.

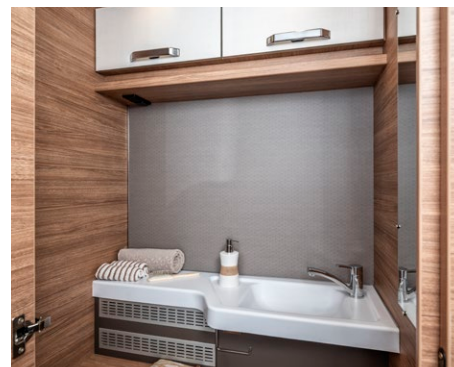

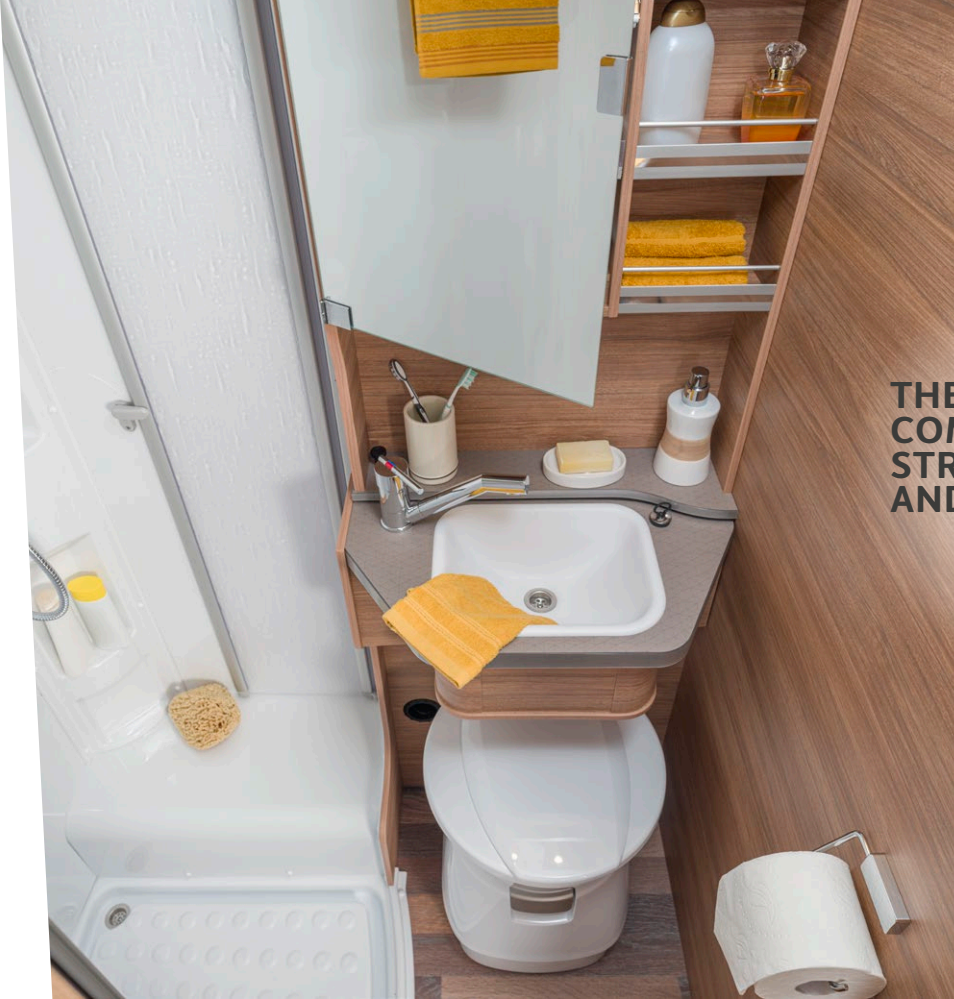

Bath in the 650 MEG

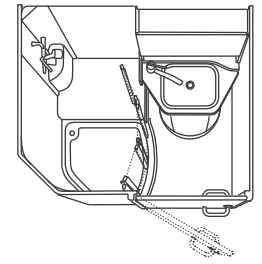

**THE COMPACT BATHROOM. STRAIGHTFORWARD AND CLEAR.**



**Characterised by strong design accents.** The characteristic design language of the CaraCore is also evident in its bathroom. The design is straightforward and clear, and thanks to the many storage options and practical details, you immediately feel at home.



**Behind closed doors.** Our room bathroom is a dream bathroom, because it can be used flexibly. Either we close the door to the living room and have a large bathroom or we are happy to have the option of using the shower and toilet separately.

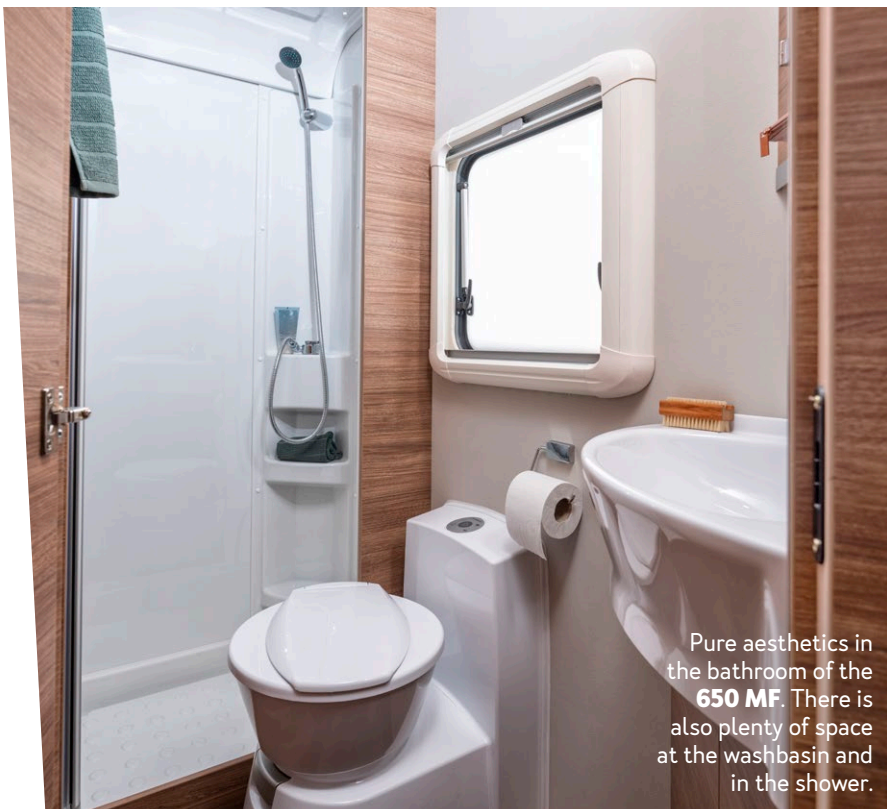

Pure aesthetics in the bathroom of the **650 MF**. There is also plenty of space at the washbasin and in the shower.



**LONGI-TUDINAL BATH. ALL IN ONE LINE.**

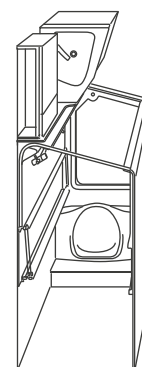

Bath in the 650 MF

# HIGHLIGHTS. CONVINCES WITH ELABORATE DETAILS.

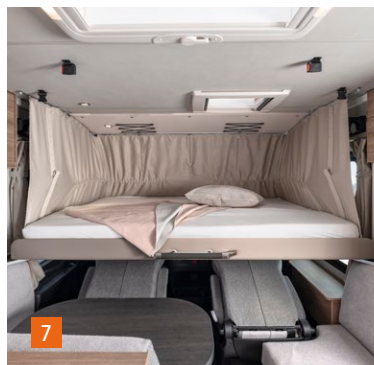
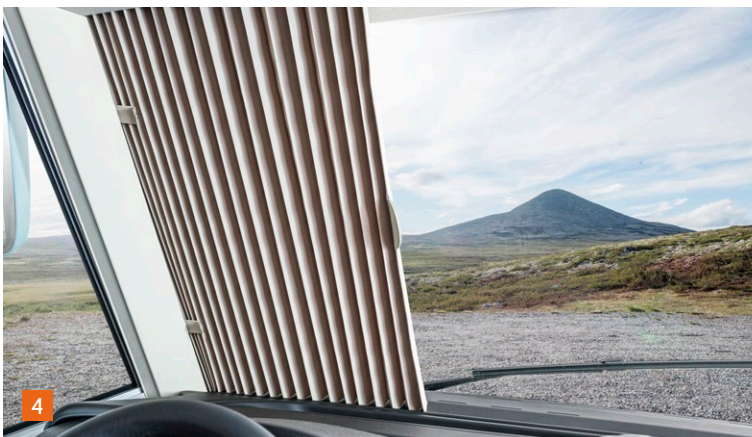

**1. The new optional cab seats from AGUTI.** Guarantee optimum travel comfort.

**2. Full-LED headlights.** Latest technology, best visibility and safety thanks to the distinctive light signature.

**3. Soft-close drawers.** Great comfort thanks to the soft and quiet closing of the drawers.

**4. Manual or electric front shading.** Creates privacy on the campsite for the night.

**5. 700 mm wide KOMFORT body door.** With automotive locking system, double seal and a foldable coat hook.

**6. Easy-Travel-Box and bluuwater waterfilter.** All important service connections centrally combined in one place and hygienically clean water without chemicals.

**7. The better semi-integrated with lifting bed as standard.** The lifting bed can be lowered above the driver and passenger seats, and the dinette can be used even when the bed is used.

**8. Optional ALDE hot water heating and ALDE hot water underfloor heating.** Ensure pleasant room temperature and no cold feet.

# LAYOUTS. TAILORED TO YOUR REQUIREMENTS.



**650 MF**

**STRENGTHS:**

- Central dinette
- French bed
- 5 berths
- Up to 5 belt-secured seats

The combination of lifting bed and longitudinal seat in the dinette create an open living space. The French bed and longitudinal bath provide comfort in the rear.

**The aesthetic one with an open feeling of space.**



**650 MEG**

**STRENGTHS:**

- Central dinette
- Longitudinal single beds
- Spacious rear garage
- 4 berths
- 4 belt-secured seats

An elegant room concept with lifting bed and high-quality single beds. Ideal for all those who want to travel in style, like to sleep particularly comfortably and at the same time value driving comfort.

**The elegant one with convincing comfort.**

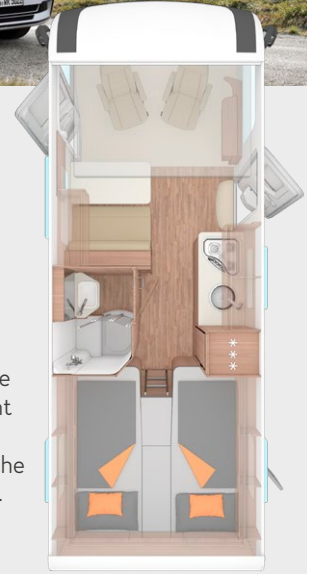

**700 MEG**

**STRENGTHS:**

- Central dinette
- Longitudinal single beds
- Spacious rear garage
- Up to 5 berths
- Up to 5 belt-secured seats

This layout with lifting bed is spacious, both in the kitchen and the largest bathroom in its class. The longitudinal single beds are a perfect retreat for those who value comfort.

**The stylish one with impressive living space.**



**NOW NEW  
SUPERLIGHT-  
TECHNOLOGY**  
You can find more  
information on  
page 112.



Diversity and choice wherever you look. Design your motorhome just the way as you like it.



Motorhome expertise. This does not only stand for technical sophistication, but also for a wide range of options. After all, your motorhome should be just as individual as your holiday plans. A wide range of layouts, beds, bathrooms and kitchens await you, from which you can put together your motorhome exactly the way it suits you.

## DOORS. WITH MANY INNOVATIVE FUNCTIONS.



Innovative: The one-key locking system with inside track keys and outside handles and locks for body doors and service flaps.

Available in 600 mm and 700 mm width (depending on floor plan).

EQUIPMENT	COMFORT*	PREMIUM**	EXCLUSIVE**
With windows incl. blackout		•	•
Multiple lock		•	•
Driving rain seal (double seal)	•	•	•
Automotive locking system	•	•	•
2 coat hooks, foldable	•	•	•
Limit stop hardware with gas pressure spring		•	•
Umbrella compartment		•	•
Concealed hinges		•	•
Multifunctional bag		•	•
Central locking system			•
Coming Home Lighting			•

\* Standard with CaraCompact, CaraHome, CaraLoft, CaraSuite and CaraCore

\*\* Optional for all WEINSBERG motorhomes





## ALLOY RIMS. IN EXCLUSIVE WEINSBERG DESIGN.



**1**  
**Anthracite painted  
17" alloy rims incl. tyres**  
in exclusive WEINSBERG design  
(235/60R17)



**2**  
**Matt black front-polished  
17" alloy rims incl. tyres**  
in exclusive WEINSBERG design  
(235/60R17)



Our 17" alloy rims in WEINSBERG DESIGN are equipped with high-quality Falken all-season tyres as standard which can also be driven in winter on ice and snow.

- M+S / 3PMSF identification
- No more buying winter tyres
- No additional investments

You can find all rim and tyre options online at: [configurator.weinsberg.com](http://configurator.weinsberg.com)

## FABRICS. AS YOU PREFER THEM.

### STANDARD



TURIN [STANDARD]\*



MALABAR [STANDARD]

Exclusively for CaraCompact EDITION [PEPPER].

### AVAILABLE WITHOUT SURCHARGE\*



STONE WATER



FOREST



BLOOM



DUSK

\*Not available for CaraCompact EDITION [PEPPER].

### AVAILABLE AGAINST SURCHARGE\*

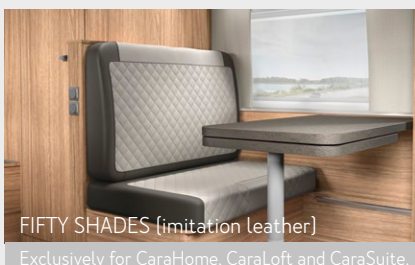

FIFTY SHADES (imitation leather)

Exclusively for CaraHome, CaraLoft and CaraSuite.



SZECHUAN



ACTIVE NAVY

\*Not available for CaraCompact EDITION [PEPPER].

# BEDS. SLEEP AS YOU PLEASE.

Wake up well-rested on every single morning. At WEINSBERG we know how important good sleep is for the holiday experience. That is why all bed variants and layouts are designed with generosity and comfort in mind. Thanks to the large range, everyone will find their perfect sleeping place.

## TRANSVERSE DOUBLE BED. EFFICIENT ALL-ROUNDER.



The comfortable transverse double bed uses the entire width of the vehicle for itself. So you can enjoy a particularly long bed surface as well as a great feeling of space.

Cara**Home** 550 MG / 650 DG  
Cara**Suite** 650 MG

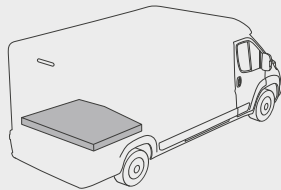

## FRENCH BED. SLIGHTLY ANGLED.



The French bed offers a particularly elegant room solution. Cosy nights are pre-programmed here. Unique is the practical proximity to the bathroom.

Cara**Compact** 600 MF  
Cara**Loft** 600 MF / 650 MF  
Cara**Suite** 650 MF  
Cara**Core** 650 MF

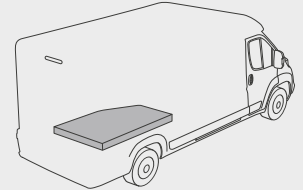

## LONGITUDINAL SINGLE BEDS. SPREAD AND BROADEN.



Up to 200 cm in length offer more than enough room to stretch out really nicely. If you want, you can optionally convert the two single beds into one large double bed.

Cara**Compact** 600 MEG  
Cara**Loft** 650 ME  
Cara**Suite** 700 ME  
Cara**Core** 650 MEG  
700 MEG  
Cara**Home** 650 MEG

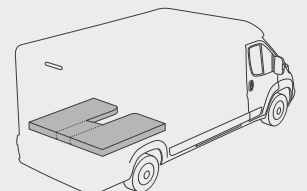

More information online at [weinsberg.com/motorhome-variants](https://weinsberg.com/motorhome-variants)

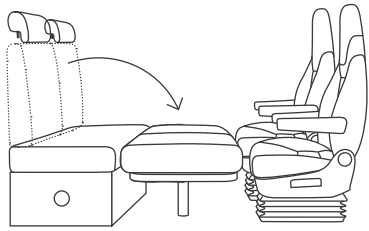

Also very practical:  
The dinettes in the vehicle  
can be quickly converted  
into an additional  
sleeping place.



### LIFTING BED. COMFORT TO LOWER.

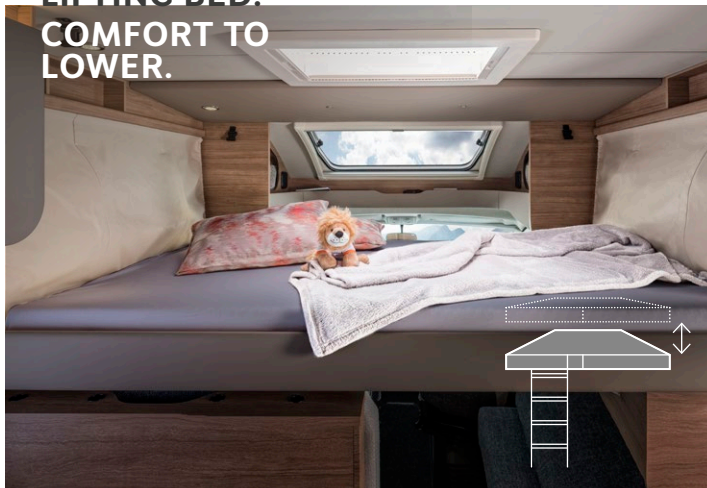

Hardly noticeable during the day, the cuddly cave appears in a jiffy in the evening. When raised, the spacious sleeping area is almost invisible and perfectly secured with click fasteners and safety belts.

- CaraSuite 650 MF  
650 MG / 700 ME
- CaraCore 650 MF  
650 MEG  
700 MEG

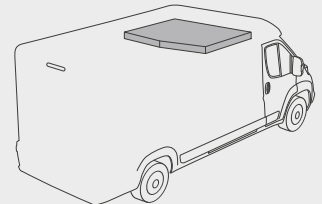

### ALCOVE BED. SLEEPING UPSTAIRS.

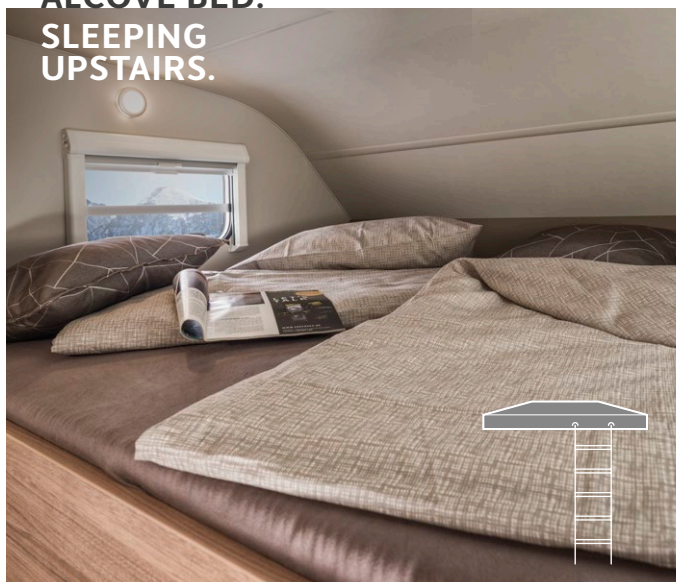

The ladder leads to the comfortable alcove bed which is almost like having your own room. The two hinged windows and the roof hatch provide a pleasant sleeping climate.

- CaraHome 550 MG / 600 DKG /  
650 MEG / 650 DG

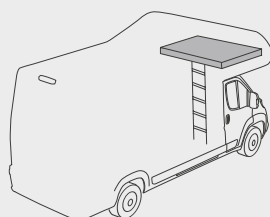

### BUNK BED. ON TOP OF EACH OTHER INSTEAD OF SIDE BY SIDE.



Ideal for children is the bunk bed with safety net as standard. A perfect retreat for the little ones.

- CaraHome 600 DKG

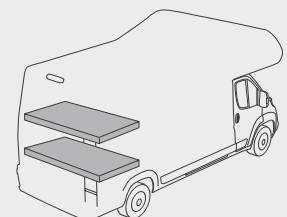

# KITCHEN. THE RIGHT LIVING RECIPE FOR EVERYONE.

The kitchen is the heart of the home - and of course the motorhome. Thanks to robust work surfaces, plenty of space for utensils and high-quality appliances, cooking is really fun.

## COMPACT KITCHEN. SPACE FOR THE ESSENTIALS.

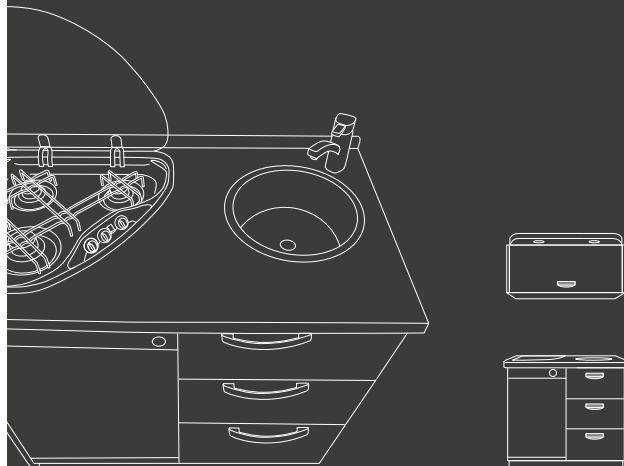

In the compact kitchen, the refrigerator is integrated into the kitchen block. Everything is quickly to hand in the drawers with full extension.

CaraHome 550 MG

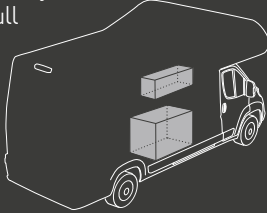

## LONGITUDINAL KITCHEN. THE SPACIOUS CLASSIC.



The spacious classic. In the longitudinal kitchen, the refrigerator is placed separately and can therefore be up to 177 litres in size. Fresh food and supplies have a particularly large space here.

CaraCompact	600 MEG / MF
CaraLoft	650 ME
CaraHome	600 DKG /
	650 MEG / 650 DG
CaraCore	650 MEG



## VIS-À-VIS KITCHEN. UNIQUE PLACEMENT.



In the vis-à-vis kitchen, the kitchenette is located next to the dinette. Unique is the position of the refrigerator on the opposite side.

1. CaraLoft 650 MF  
CaraSuite 650 MF  
650 MG  
700 ME
- CaraCore 650 MF  
700 MEG
2. CaraLoft 600 MF

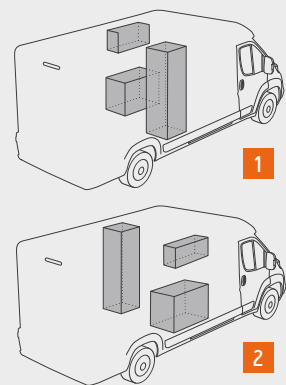

More information online at [weinsberg.com/motorhome-variants](https://www.weinsberg.com/motorhome-variants)

# BATHS. REFRESHING ROOM CONCEPTS.

In the bathroom everything is revolves around the topic of space. This is where true size is in the well thought-out solutions. Plenty of storage space, attractive design and flexible details offer space to feel good.

## COMPACT BATHROOM. COMPACT AND COMPLETE.

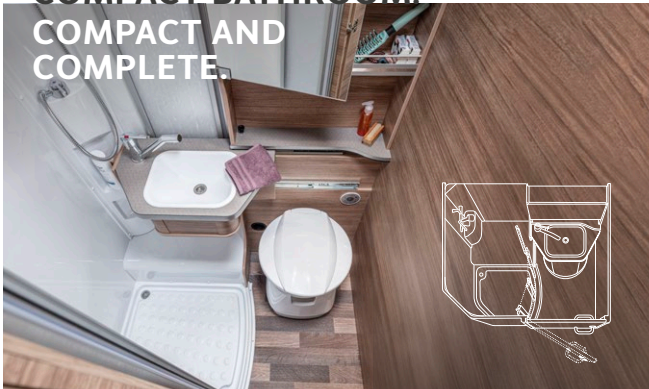

The highlight of the compact bathroom is the sliding washbasin. This functional solution enables optimum use of space even with a space-saving construction.

- Cara**Compact** 600 MEG
- Cara**Loft** 650 ME
- Cara**Home** 550 MG / 600 DKG / 650 MEG / 650 DG
- Cara**Core** 650 MEG

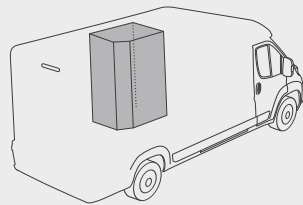

## REAR BATHROOM. LENGTH TIMES WIDTH.

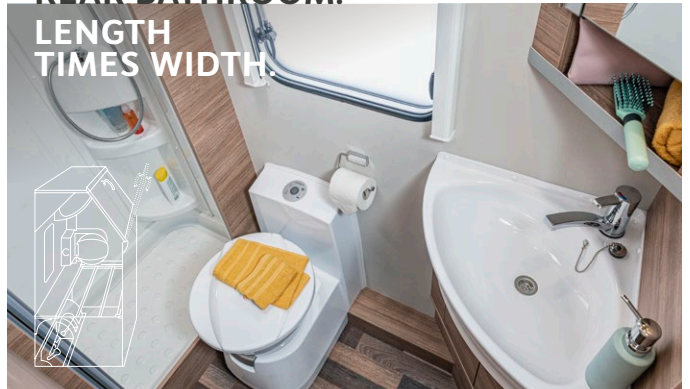

Here everything is in one central place - so everything is within easy reach. Lots of room to move and plenty of stowage options characterise the spacious rear bathroom.

- Cara**Loft** 600 MF / 650 MF
- Cara**Suite** 650 MF
- Cara**Core** 650 MF

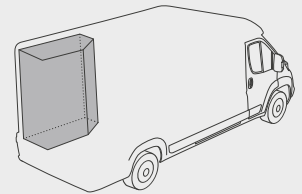

## LONGITUDINAL BATHROOM. ALL IN ONE LINE.



The ingenious partner of the French bed makes optimum use of space. This creates a unique feeling of space in the vehicle.

- Cara**Compact** 600 MF

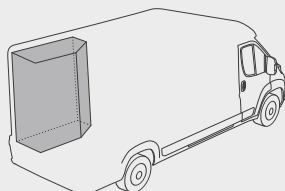

## SEPARATE BATHROOM. THE LARGEST BATHROOM SOLUTION.



Washbasin and toilet are spatially separated from the shower. When the door to the living area is closed, a large continuous bathroom is created.

- Cara**Suite** 650 MG / 700 ME
- Cara**Core** 700 MEG

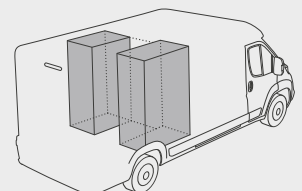

For some models, additional equipment must be selected in order to achieve the maximum possible sleeping places. Your WEINSBERG dealer will be happy to advise you.



New base vehicle

# THE NEW FIAT DUCATO 8

The FIAT Ducato has been one of the most popular base vehicles for motorhomes and CUV for 40 years. The new FIAT Ducato 8 impresses with a striking, modern look, many technological features and infotainment, as well as increased comfort and driving pleasure through driver assistance systems. With up to 180 HP and the latest EURO 6D Final standard, it offers maximum efficiency and performance.

## EXTERIOR HIGHLIGHTS.

The optional full LED headlights feature a slimmer, more elegant profile. The design is available in either aluminium or black. The light is 30% brighter than halogen headlights, increasing safety when travelling.



Dynamic LED indicator

Full LED headlights (low and high beam)

LED daytime driving lights



## NEW RADIATOR GRILLE.

New standard radiator grille in black, with chromed bar and spoiler lip in aluminium.



With the optionally available Radiator Grille Styling Package Black, everything is black: the glossy bar, the headlights and the spoiler lip.



The optimised underbody guard protects the engine compartment and further emphasises the new style.

## DIGITAL DASHBOARD.



Standard 3.5" TFT digital instrument cluster with two analogue displays.



The optional virtual cockpit with 7" TFT digital instrument cluster and two digital displays also keeps the assistance systems in view at all times.

**NEW**

## COMPLETELY NEW INTERIOR.



Visual accents are provided by the steering wheel and gear knob in leather finish (available as an option), with satinchrome surrounds and high-gloss elements.

Optional inductive charging cradle, two USB sockets and a 230 V socket provide convenience while driving.

The optional battery disconnect switch in the cab can be used to protect battery power.

## ASSISTANCE SYSTEMS.

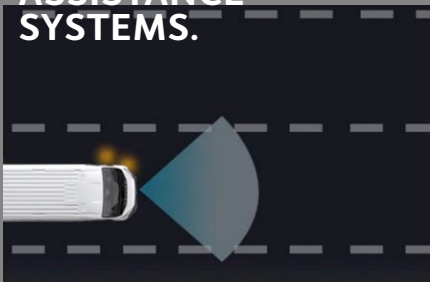

### Safety Pack Easy Driver:

The optional package provides additional safety with adaptive cruise control, intelligent speed assistant and drowsiness detection.

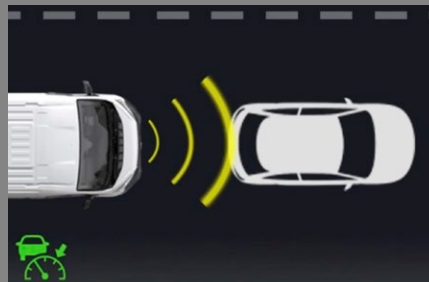

### Safety Pack FIAT:

An optional safety pack with Emergency Brake Assist, Lane Keeping Assist, Traffic Sign Recognition, Auto Low Beam, and Rain and Light Sensor.

### On board as standard:

- Cruise control
- ESP
- Hill Holder (hill start assist)
- ABS - ELECTRONIC IMMOBILISER
- Electronic immobiliser
- Electromechanical power steering
- Trailer Stability Control System
- Post Collision Braking System
- Crosswind Assist

### Optional assistance systems:

- Traction Plus™ including Hill Descent Control (optional)
- Tyre pressure sensors (optional)

NEW

**SUPERLIGHT TECHNOLOGY.**  
**MAXIMUM WEIGHT REDUCTION.**



**Put an end to stress.** SUPERLIGHT is more than just leaving something out. It is a revolutionary technology that ensures maximum weight savings. The result: you can take more with you on your travels without having to sacrifice equipment. SUPERLIGHT can be found in the CaraHome 650 DG and CaraCore 700 MEG. Just start thinking about what you want to pack!

You can find more information at [weinsberg.com/superlight](https://weinsberg.com/superlight)

Gain of almost **30%** additional payload\*



New and more stable seat construction in lightweight technology.



New and better insulated bow fender in sandwich construction.

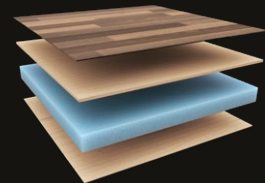

Better insulated and more stable floor panel with 52 mm and XPS foam technology.

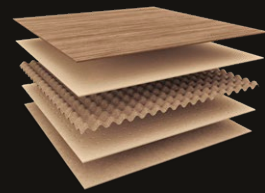

Furniture construction with fronts made of high-strength lisocore® lightweight panels.



Enormous additional weight saving thanks to more powerful lithium-ion battery (optional).



Extremely light leaf springs made of high-tech plastic.



Lightweight high-frame chassis (CaraHome 650 DG).

\* This corresponds to up to 155kg payload.



**THULE  
AWNINGS\*.  
FOR EVEN  
MORE  
COMFORT.**

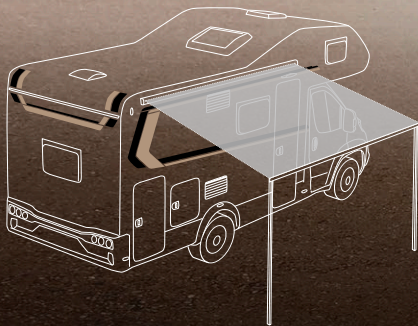

**Always well protected.** Awnings from the quality manufacturer Thule make your WEINSBERG holiday even more pleasant. As effective protection from sun, rain and wind, they also create a cosy atmosphere and extend the living space at the campsite. Our awnings are available in various sizes (depending on the layout) and impress with their special durability thanks to waterproof, wind-resistant PCR fabrics, simple assembly and absolute stability.



**Flexible.** The emergent angle can be adjusted as you wish. This allows you to close and open the awning even when the door to your WEINSBERG is open.



**Foldout.** The supports have an articulated joint. The vertical lowering system prevents damage to the vehicle.



**Practical.** Quick Lock system for easy assembly and adjustment of the support feet.



**Quality.** The PCR cloth is evenly tensioned by the diagonal tensioning arms and can be locked into place at different levels.

	355x250cm	405x250cm	455x250cm	500x250cm
CaraCompact	-	600 MEG / MF	-	-
CaraLoft	600 MF	650 ME / MF	-	-
CaraSuite	-	650 MF / MG / 700 ME	-	-
CaraHome	550 MG	-	650 DG	-
CaraCore	-	-	650 MF / MEG	700 MEG

\* Components optionally available.

# INTELLIGENT DEVICES, MAXIMUM COMFORT.



## BLUWATER\*. Water filter system.

Hygienically perfect water at every destination - the new bluuwater water filter removes germs, bacteria and minute particles almost completely (99.999 %) from the pipe system of all Knaus Tabbert vehicles (in series). The replaceable filter cartridge with highly efficient ultrafiltration membrane is mounted vertically or horizontally between the water tank and the pipe system. It has a filter capacity of up to 8,000 litres - and thanks to a Timestrip indicator in the vehicle, the remaining usage time can be checked at any time. It is advisable to replace the bluuwater cartridge after about six months. Thanks to the click-and-ready quick coupling system, it can be replaced easily and drip-proof.



bluuwater

## PIONEER NAVIGATION SYSTEM. [AVIC – navigation]\*.



Europe navigation specially for motorhomes and CUV in 44 countries; promobil campsite finder; secure smartphone operation with voice control; clear and high-contrast 9" multi-touch display; Wireless compatible with Apple CarPlay, android auto and Weblink; integrated DAB+ receiver; including 3-year map update.



## PIONEER HEAD-UP-DISPLAY\*.

The integrated head-up display provides even more safety. All relevant data directly in the field of vision so that the driver's eyes always stay on the road. Navigation instructions from the Navigat Evo are also displayed.

## VELOCATE GPS TRACKER WITH NEW FUNCTIONS\*.

*More safety for your WEINSBERG.*

Velocate's innovative GPS tracking system works with intuitive app control and silent alarm mode. In the event of theft, Velocate can help you retrieve your motorhome. The powerful self-contained running time of up to 3 months without power leaves nothing to be desired. The GPS tracker can be upgraded with Bluetooth sensors and a reed contact: So you can check the gas bottle level and the temperature of your WEINSBERG in the app at any time.

In addition, the hardware is prepared to be expanded via optional sensors (e.g. door/window contact). For more information, please visit [www.velocate.com](http://www.velocate.com) or [www.weinsberg.com](http://www.weinsberg.com).

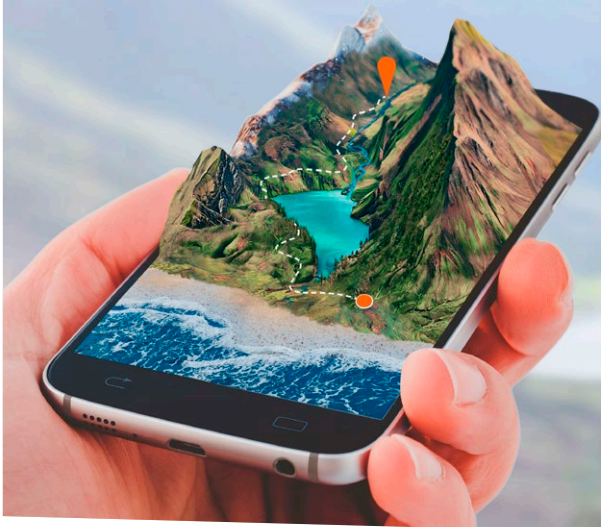

## TRUMA INETX SYSTEM\*.

*Turn your WEINSBERG into a smart home.*

The practical TRUMA iNetX System with intuitive smartphone app control via Bluetooth allows you to control heating, interior and exterior lighting as well as TV and radio in your mobile home from anywhere. The colour 4.3" touch display shows outdoor and indoor temperature and can operate devices from TRUMA and Dometic. The intuitive user interface makes monitoring and control particularly pleasant, clear and simple.



Heating systems\*



## E.HIT\*.

*Integrated rear carrier.*

Extremely practical: the rear carrier can be extended electrically, has a high load-bearing capacity of up to 150kg and is combined with a detachable trailer coupling. At the push of a button, two swivel arms extend, then the accessory base with its retractable LED is pushed onto it and a connection between the electrics of the taillight carrier and the motorhome is established.

## THULE\*.

*Bike carrier.*

In addition to the integrated rear carrier e.hit, WEINSBERG also offers bicycle carriers for up to 4 bicycles, the height-adjustable bicycle carrier Thule Lift V16 or Thule G2 ideal for your e-bikes.

\* Components optionally available.

## SILWYREADY\*.

*For relaxed travelling.*



The silwy MAGNETIC SYSTEM promises no more slipping, falling or rattling glasses. With the ingenious magnetic system, the magnetic glasses adhere to metallic nano-pads or metallic accessories specially developed for silwy and thus offer absolutely safe and relaxed travelling. From now on all WEINSBERG motorhomes are silwyREADY. The silwyREADY package includes a small round, removable silwyPad with a magnetic pin, which sticks to a kitchen wall unit with a welcome sign. Later, the pad can be placed anywhere in the vehicle to serve as a coat or towel hook. In one of the kitchen ceiling cupboards you will find a silwy metal mat with leather-look surface glued in. Thanks to the magnets in the base, silwy glasses placed there are vibration-proof and stable.

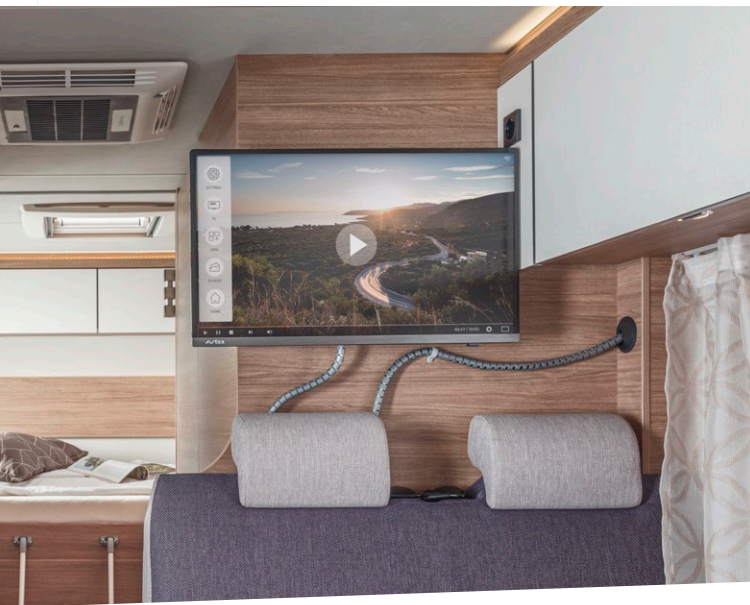
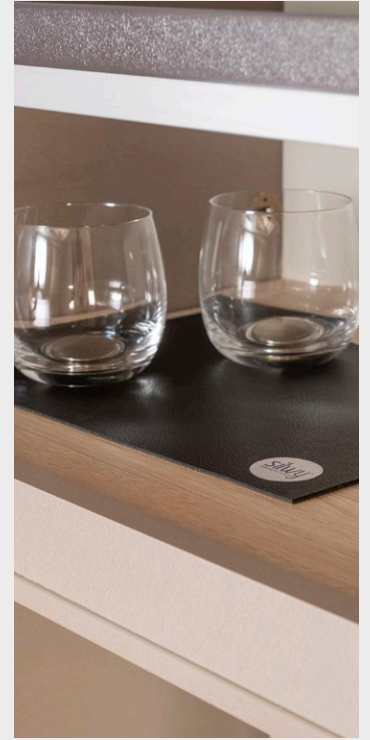

## SMART-TV\*.

*Home cinema on the move.*

Watch what you want, where you want. The future of television is now moving into your WEINSBERG. With the optional TV package, only Smart TVs are installed. This means you can enjoy all the benefits of Video on Demand on the move, simply via a mobile hotspot or the WIFI on the campsite. Streaming your favourite series and films provides that little bit of extra comfort on your holiday.

## MEDIKIT VOUCHER.

*Exclusive medication set.*

Your WEINSBERG motorhome now also contains a voucher for a MediKit. This contains various pharmacy-supplied medicines that may be useful when travelling, including painkillers, anti-allergics or tablets for diarrhoea. So you're always well taken care of.\*\*

\*\* A voucher to redeem the medicine set is enclosed with the vehicle. The medicine set contains medicines that must be purchased from a pharmacy. The voucher can therefore only be redeemed at the responsible MediKit mail-order pharmacy at [www.meditkit.shop](http://www.meditkit.shop). At [www.meditkit.shop](http://www.meditkit.shop) you will also receive further information about your MediKit.



EVERYTHING THAT  
MAKES YOUR HOLIDAY  
EVEN BETTER.

## THE FRANKANA FREIKO WEINSBERG Kollektion.

Available at your WEINSBERG  
dealer or at: [shop.weinsberg.com](http://shop.weinsberg.com).

**1. Drinking bottle 800 ml** Classic Sport made of stainless steel. Easy to clean. Dimensions: 7x 25 cm. Weight: 256 g. Article no. 6511023

**2. Camping chair** made of round aluminium tube. eightfoldly adjustable, 76 cm high backrest. Load capacity up to: 100 kg. Frame: aluminium. Pack size: 107 x 69 x 5 cm. Article no. 6511022

**3. Camping table Accordeon** by Duldalf with weatherproof Sevelite tabletop. Height adjustable: 57 - 74 cm. Dimensions: 100 x 68 cm. Material: steel. Load capacity up to: 50 kg. Weight: 11 kg. Article no. 6511021

**4. Handcart** with 10 cm wide profiled wheels and load capacity up to 75 kg. Dimensions: 131 x 60 x 98 cm. Weight: 11.9 kg. Article no. 51 011

**5. Four mugs** of high-quality Resylin. With anti-slip system. Article no. 6511024

**6. Gas adapter set** – contains everything you need to connect a pressure regulator (G12, Germany) to gas cylinders commonly used on the European market. Article no. 6511025

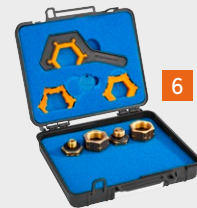

All information and prices can be found at:  
[www.frankanafreiko.delen](http://www.frankanafreiko.delen)

 Frankana Freiko®

## COZY HOME DECO PACKAGE.

*You have the choice.*

Package includes: 4 pillows with feather filling  
(2x 60x40 cm & 2x 40x40 cm),  
2 blankets and a matching table runner.

FOR EVERY  
WEINSBERG

OPTIONALLY  
AVAILABLE



AQUA



MAGNOLIA



EARTH



AVOCADO



PEACH



STONE



## CHOICE MADE EASY.

How can you make a decision with so much choice? It's easy: with our practical online tools, it's super simple. They help you find the WEINSBERG of your dreams.

### CaraView

#### Configurator

Design your individual motorhome. For which layout and whichever equipment you decide on, make it your personal dream vehicle under: [configurator.weinsberg.com](http://configurator.weinsberg.com)

[configurator.weinsberg.com](http://configurator.weinsberg.com)

#### Layout finder

Family carriage or an adventure vehicle for two? Find out which travel companion perfectly fits you: [layoutfinder.weinsberg.com](http://layoutfinder.weinsberg.com)

[layoutfinder.weinsberg.com](http://layoutfinder.weinsberg.com)

### Dealer Search

We know: It is not easy to decide for "the one WEINSBERG"! Our dealer search helps you to find a trade partner in your area. Visit your desired model directly on site and get detailed advice.

[dealer.weinsberg.com](http://dealer.weinsberg.com)

Now rent abroad as well!

## SO HEDGE THEREFORE, WHO JOIN FOREVER ...

RENT AND TRAVEL  
URLAUB MIT DEM WOHNMOBIL



### RENT AND TRAVEL NOW ALSO AS AN APP

Experience your holiday even more mobile with the following functions:

- Booking status overview
- Push messages
- Online check-in
- Payments
- Instruction videos
- Checklists
- Station Details
- Rental offers
- Emergency assistance
- and much more..

[www.rentandtravel.delapp](http://www.rentandtravel.delapp)

You would like to buy a leisure vehicle but would like to test whether it really suits you? Then our RENT AND TRAVEL service is just right for you. Search comfortably online or in the travel agency for your favourite layout. Together with a Germany-wide network of over 170 rental stations with over 1,900 rental vehicles and more than 380 partner travel agencies, RENT AND TRAVEL supports you in your decision for the right vehicle. You can also profit from our large service portfolio, such as route

suggestions and numerous cooperations with camping and parking sites. Enjoy the practical holiday test!

- More than **1,900 rental vehicles** are available at over 170 rental stations.
- Bookable online at [www.rentandtravel.de](http://www.rentandtravel.de) or via our **380 partner travel agencies**.

Discover all rental stations on [www.rentandtravel.de/en](http://www.rentandtravel.de/en)



With the CaraLoft we got to the Ammersee lake and to the foothills of the Alps to do sports and to gather inspiration for my next cookbook. To say that the journey was beautiful is an understatement. **#teamWEINSBERG** rocks!



Available at [shop.weinsberg.com](http://shop.weinsberg.com)

**MARKUS SÄMMER**

[@thegreatoutdoorsbook](https://www.instagram.com/thegreatoutdoorsbook)



**RUDI & GERLINDE SCHARF**



It is really nice to be part of **#teamWEINSBERG!** With the wonderful CaraCore we travelled to Norway and along the fjords to the Lofoten Islands. Without time pressure, but with even more pleasure!

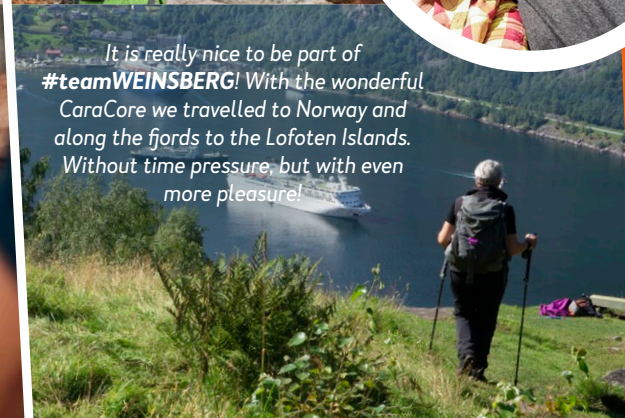

# #team WEINSBERG

Become part of the Community.

The **#teamWEINSBERG** writes travel stories and shares them with the community. The experiences are impressive!

Sharing is caring:  
What are your discoveries when travelling with a WEINSBERG?

In **#teamWEINSBERG** every body is welcome!

-  [@weinsberg\\_official](https://www.instagram.com/weinsberg_official)
-  [@WEINSBERG](https://www.facebook.com/WEINSBERG)
-  [@WEINSBERG](https://www.youtube.com/WEINSBERG)
-  [carablog.weinsberg.com](http://carablog.weinsberg.com)

**SARAH KATHARINA & ANDREAS**

[@sarahkatharinah](https://www.instagram.com/sarahkatharinah)



We were on the road in Italy with the CaraCompact and stopped wherever we liked it. The driving experience is wonderful as is the space. It's great to be part of the **#teamWEINSBERG!**



# WEINSBERG

Dein Urlaub!

RO8117613-EN



You can find our caravans and CUV in our separate WEINSBERG caravan and CUV catalogues.

Visit us on Social Media or in our fan shop!



[facebook.weinsberg.com](https://facebook.weinsberg.com)



[instagram.weinsberg.com](https://instagram.weinsberg.com)



[youtube.weinsberg.com](https://youtube.weinsberg.com)



[shop.weinsberg.com](https://shop.weinsberg.com)

The information on the delivery contents, measurements and weights as well as the appearance correspond to the knowledge at the time of printing (07/2021). We reserve the right to make changes on equipment, technical data, serial equipment and prices. After a contract has been concluded, we reserve the right to make technical changes within the framework of the construction insofar as they serve technical progress and are acceptable for the customer. Minor colour and texture deviations are also reserved - even after conclusion of the contract - insofar as these cannot be avoided due to the material (e.g. colour deviations of up to approx. 2.0 dE between paint on sheet metal and paint on GRP/plastic) and are reasonable for the customer. Some illustrations show equipment features which are not included in the serial equipment and/or which can be ordered at extra cost (optional extras), and in some cases also equipment features of prototypes/studies/country variants which do not correspond to the serial status and which cannot be ordered as optional extras. Minor colour deviations between the illustrations in the brochure and the actual vehicle cannot be completely excluded due to printing process. Therefore, before purchasing a vehicle, please seek comprehensive advice on the current status of the series from an authorised WEINSBERG dealer. The decoration shown in the catalogue is not part of the equipment supplied. The illustrations with measurements contained in our catalogues are merely non-binding examples. Measurements are only approximate values and serve only as a general illustration, they do not represent guaranteed product characteristics. Please also note the comments in the current price list, in particular on weights, payload options and tolerances. Reprinting, even in extracts, is only permitted with the prior written permission of Knaus Tabbert AG. Errors and misprints are reserved.

[www.weinsberg.com](https://www.weinsberg.com)

**Knaus Tabbert AG** Helmut-Knaus-Str. 1 D-94118 Jandelsbrunn